

Keyfix[®]

NCCT
Non-combustible
Cavity Tray System
Installation Guide

Setting New Standards

NCCT

Non-combustible Cavity Tray System

Keyfix is setting new standards in the delivery of non-combustible cavity systems for projects requiring Document B compliance. In buildings utilising steel frame systems in the external cavity, the innovative Keyfix Non-combustible Cavity Tray System is a practical solution to provide DPC protection over lintels, masonry supports, soffit systems and other elements in the cavity such as fire barriers.

- ✓ Self-supporting
- ✓ Integral Stop Ends
- ✓ Bond/coursing adjustability
- ✓ No sealants required
- ✓ Available for all cavity configurations
- ✓ No Thermal Bridging

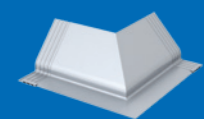

(External) Corner Unit

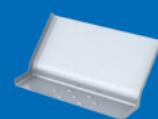

Brick Tray

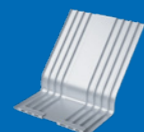

Jointing Piece

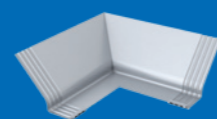

(Internal) Corner Unit



Keyfix NC Stainless Steel Weep

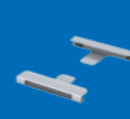

Lower Clip



Contents

Component Coding Explained	05 - 17
Installation Guide	18 - 31



NCCT Components



NCCT Component Coding Explained

BT	JP	RL	RR	SL	SR
Brick Tray	Joining Piece A short ribbed section which underlaps and connects two abutting Brick Trays (BT).	Rib Left Ribs on LHS of component when viewed from outside.	Rib Right Ribs on RHS of component when viewed from outside.	Stop Left Stop End preformed on LHS of component when viewed from outside.	Stop Right Stop End preformed on RHS of component when viewed from outside.
i	SCP	RSE	-50		-100
Internal Corner	Stepped Capping Piece	Retrofit Stop Ends	NCCT to project 50mm within cavity		NCCT to project 100mm within cavity

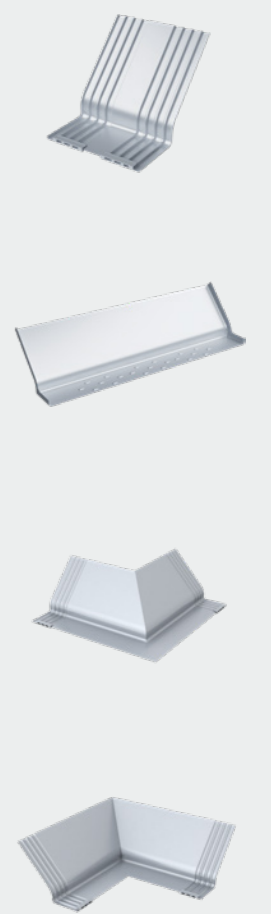

BT Brick Trays

Brick Trays are modular units which are fabricated to suit brick coursing. Keyfix manufacture trays in half brick increments from a 1 Brick Tray to 10 Brick Tray to suit any brick size or bond pattern.

Brick Trays are specified depending on the run of brickwork, taking into account the additional adjustability available when overlapping Corner Units. Each Brick Tray is formed with an integral Stop End at each end, which prevents moisture travelling horizontally and ensures it can only escape via a Weep.

Each Brick Tray also has a patented indented surface providing a physical key within the mortar bed, which eliminates risk of slip plane developing. Indented surfaces are created with no perforations on Brick Trays, eliminating the risk of rising damp.

The adjacent Brick Tray is coded as
4BT

LOCATION			
1	4BT		

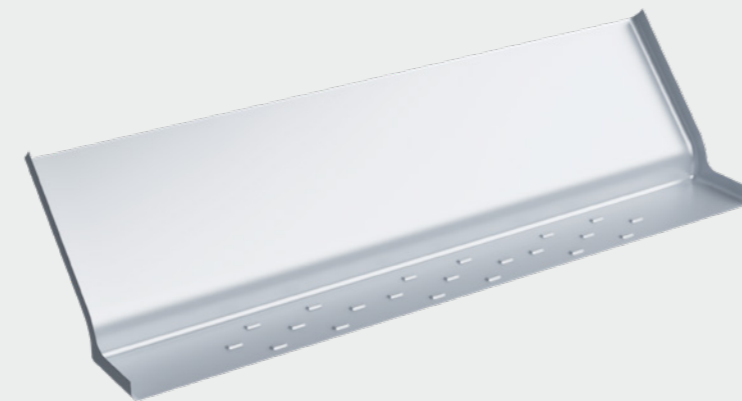

Brick Trays are coded regarding the run of brick that will be built in to them i.e.				
1BT	1.5BT	2BT	2.5BT	3BT
1 Brick Tray	1.5 Brick Tray	2 Brick Tray	2.5 Brick Tray	3 Brick Tray

JP Jointing Piece

A Jointing Piece is used to join together two abutting Brick Trays where the integral Stop Ends abut each other, therefore allowing the NCCT system to remain continuous over a run of brickwork.

By locating Brick Trays into the Lower Clip that are pre-fitted to the Jointing Piece, this provides an underlap that will drain any moisture present between the abutting Stop Ends. The perp joint between two abutting Brick Tray Stop Ends must be fully filled with mortar.

The adjacent Brick Tray is coded as
2BT JP 2BT

LOCATION			
1	2BT	JP	2BT

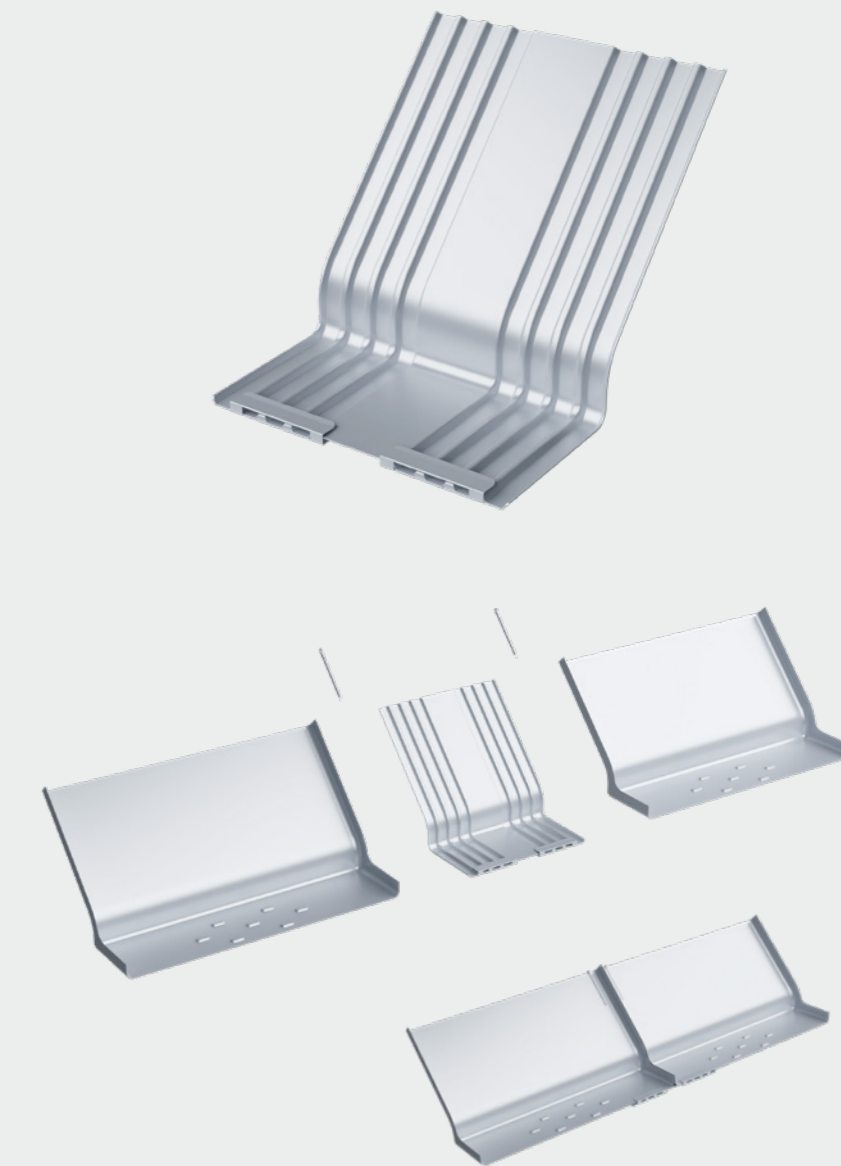

Corner Units

Corner Units are required on every project in order for the Non-combustible Cavity Tray System to continue around corners on a building or at a brick return reveal.

Corner Units are appropriately sized to allow for adjoining Brick Trays to overlap by ½ to 1 ½ Bricks, therefore accommodating varying brick coursing or cut brick dimensions. Keyfix provide a full range of prefabricated Corner Units to suit external and internal returns.

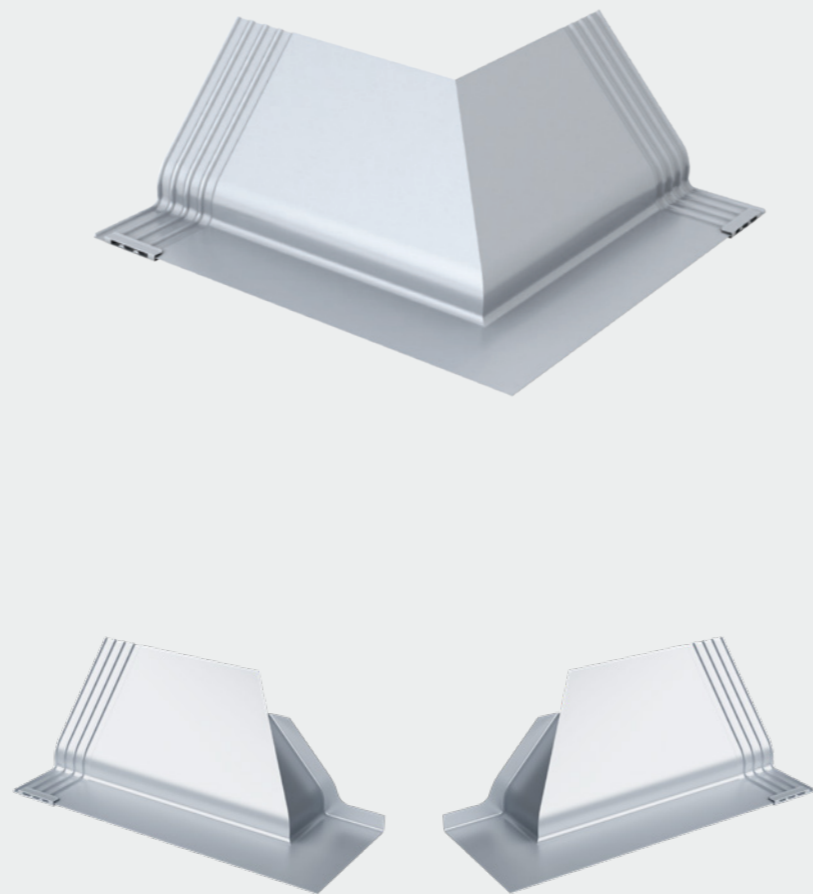

Ribbed Overlapping Joints

Ribs formed by downward pressed channels within the tray profile are an essential feature of the Keyfix NCCT system. When a Brick Tray overlaps preformed Ribs on a Corner Unit, then a mechanical dry seal joint is created and is referred to as the Ribbed Overlapping Joint or Ribbed End. The Ribbed Overlapping Joint eliminates the use of any sealants, mastics or tapes at joints. Thus giving unrivalled joint integrity lifespan and removes all installation errors associated with onsite conditions such as dust, moisture or low temperatures which can prevent 'wet' joints performing, resulting in water ingress.

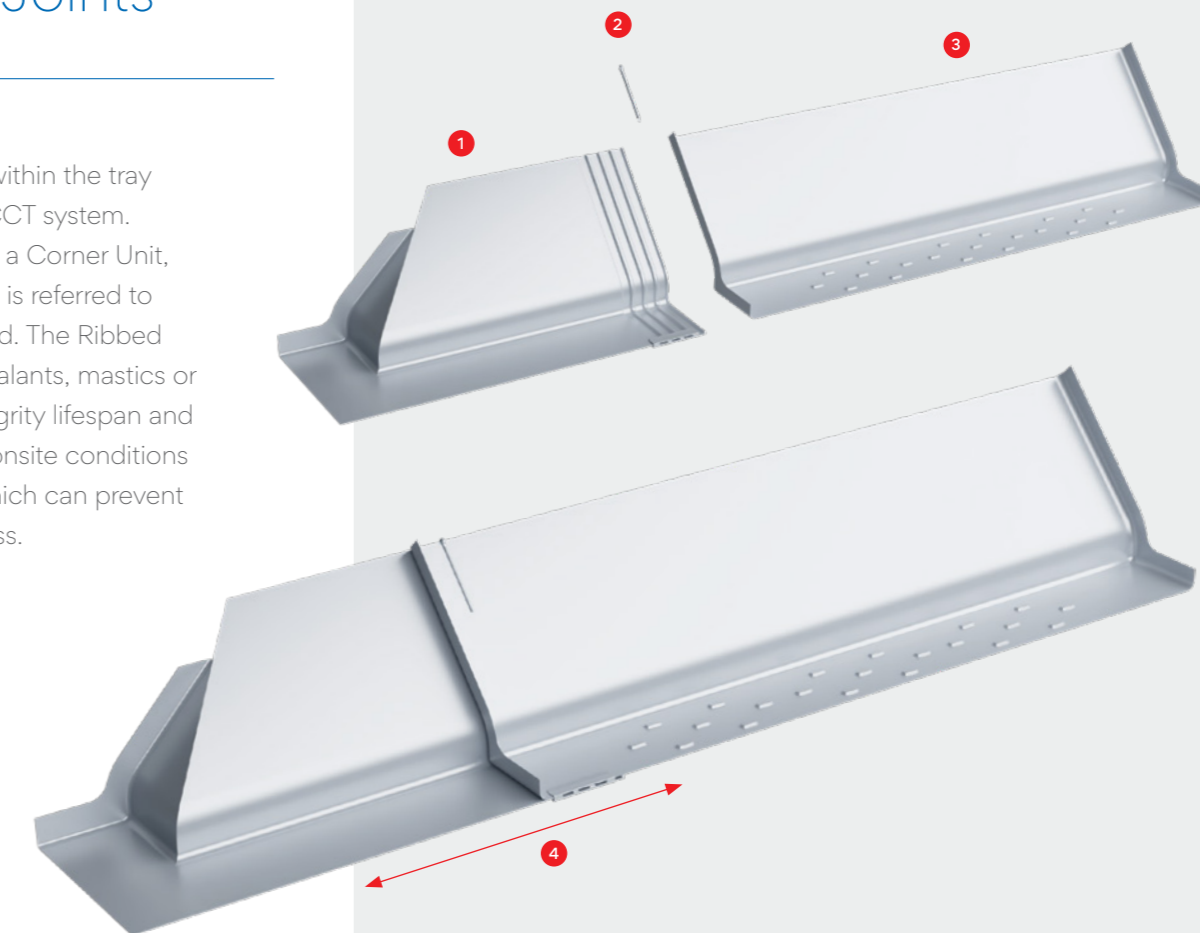

- 1 Keyfix LH Reveal Corner Unit with Ribbed Overlapping
- 2 Split Pin
- 3 Brick Tray
- 4 Brick Tray can be adjusted to achieve ½ Brick to 1 ½ Brick overlap

RL 550 x 550 RR Ribbed Overlapping Joints

Therefore the External Corner Unit shown in Figure 1 is coded as:
RL 550 x 550 RR.

When reading the Keyfix Component schedule, all components are coded from left to right, when viewed from external face of brickwork.

Firstly describing if a Stop End or Ribbed End occurs, then stating the leading dimensions. Units are then closed out by again stating any Stop End or Ribbed End.

- ✓ Ribbed End to the LHS.
- ✓ First leading dimension is 550mm.
- ✓ The unit then has an external corner so requires no other prefix other than a "x" to signify the transition from one leading dimension to the next.
- ✓ Second leading dimension is 550mm.
- ✓ The unit is closed with a Ribbed End to the RHS.

The adjacent Brick Tray is coded as
RL 550 x 550 RR

LOCATION			
1	RL550	550RR	

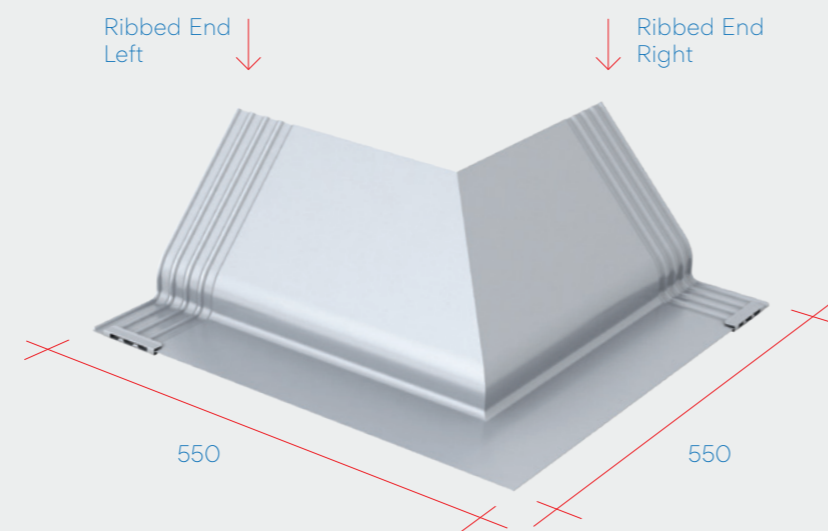

Figure 1

RL 450 i x i 450 RR Ribbed Overlapping Joints

Therefore the Internal Corner Unit shown in Figure 2 is coded as:
RL 450 i x i 450 RR.

- ✓ Ribbed End to the LHS.
- ✓ First leading dimension is 450mm.
- ✓ The unit then has an internal corner. This is identified by an "i" on either side of "x" to signify the transition from one leading dimension to the next.
- ✓ Second leading dimension is 450mm.
- ✓ The unit is closed with a Ribbed End to the RHS.

The adjacent Brick Tray is coded as
RL 450 i x i 450 RR

LOCATION			
1	RL450i	i450RR	

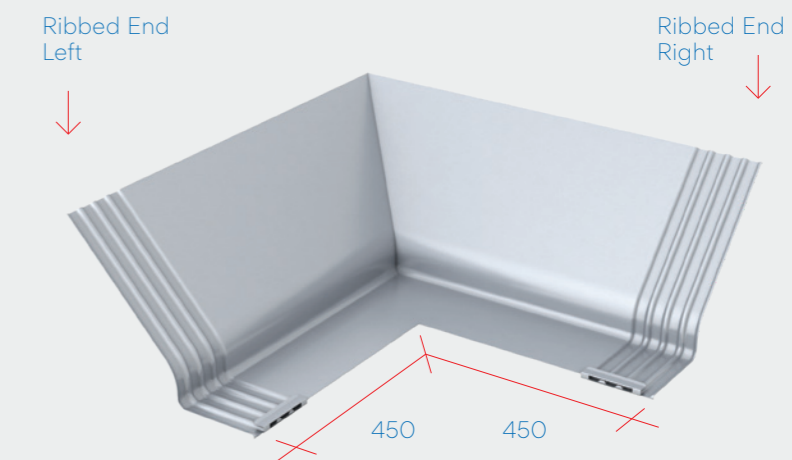

Figure 2

Technical Note

External Corner Units have a leading dimension of at least 550mm on either side. Internal Corner Units have a leading dimension of at least 450mm on either side. This is to allow for overlapping of the adjoining Brick Trays. The Brick Tray can overlap minimum of ½ Brick to a max 1½ Bricks, allowing adjustability to match coursing onsite.

Pier Units

Pier Units are fabricated bespoke depending on project requirements so one single Non-combustible Cavity Tray piece can be used in congested locations. Such as an 890mm pier between two openings.

The unit is coded from left to right, when viewed from the outside. Firstly describing if a Stop End or Ribbed End occurs, then stating the leading dimensions. Units are then closed out by again stating any Stop End or Ribbed End.

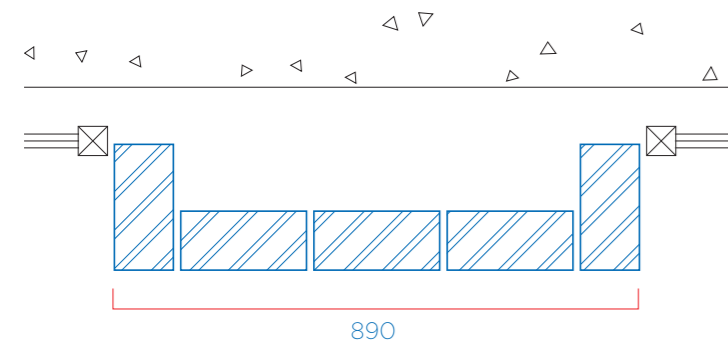

SL 205 x 870 x 205 SR Pier Units

Therefore the Pier Unit shown in Figure 3 is coded as:
SL 205 x 870 x 205 SR.

- ✓ Stop End to the LHS.
- ✓ First leading dimension is 205mm (in this example to facilitate a 215mm brick return reveal).
- ✓ The unit then has an external corner identified by a "x".
- ✓ Second leading dimension is 870mm. This is to suit 890mm brickwork dimension.
- ✓ Followed by a second internal corner identified by a "x".
- ✓ Third leading dimension is then 205mm.
- ✓ The Pier Unit is closed with a Stop End to RHS.

The adjacent Brick Tray is coded as
SL 205 x 870 x 205 SR

LOCATION			
1	SL205	870	205SR

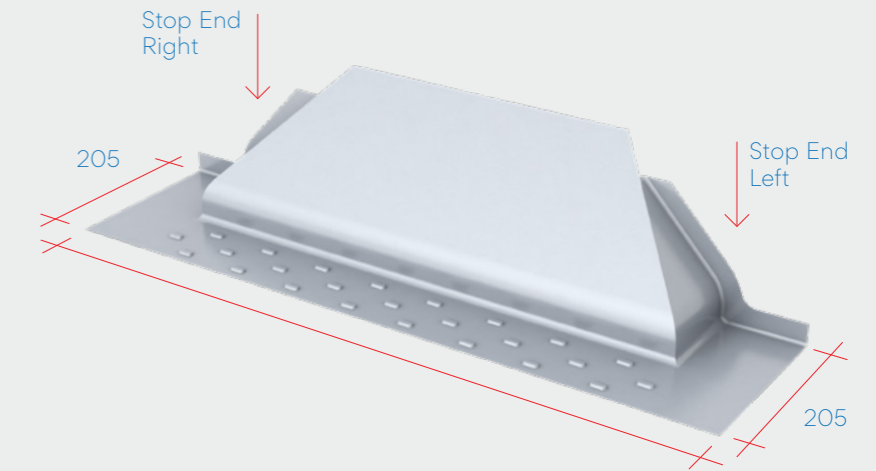

Figure 3

SCP Stepped Capping Piece

A Stepped Capping Piece is utilised when a Jointing Piece cannot be used because of a step in the panel of brickwork.

By placing a Stepped Capping Piece over the top of the abutting Brick Tray Stop Ends, this allows the NCCT system to remain continuous across the cavity, over a run of brickwork, while also accommodating the step in brickwork.

It is critical that the perp joint between abutting Brick Tray Stop Ends is fully filled with mortar between and on top of Stop Ends before placing Stepped Capping Piece over the top of Stop Ends.

The maximum allowable step in brickwork which can be accommodated is 50mm. Outside of this range, a prefabricated Corner Unit must be considered.

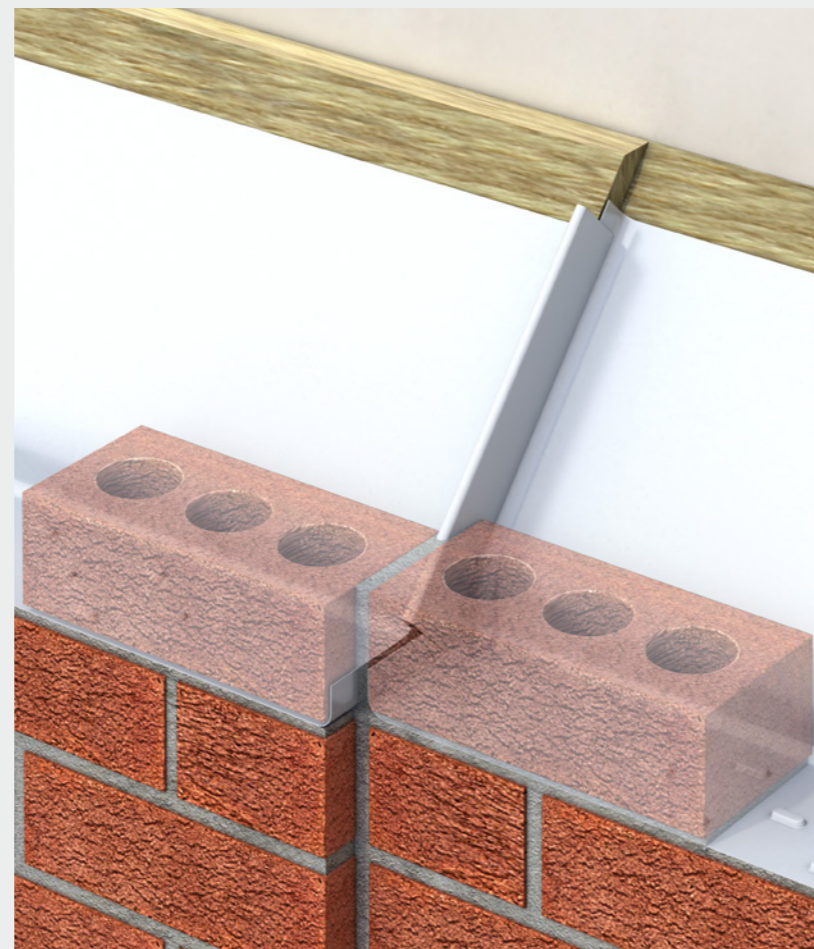
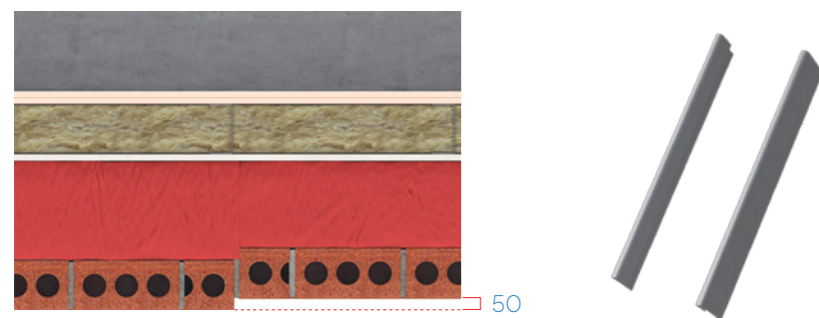

RSE Retrofit Stop End

Retrofit Stop Ends are a feature within Keyfix NCCT system that can be utilised where it is not possible to determine the brick bond set-out. This facilitates for perp joint adjustability onsite in scenarios where it is not possible to plan for the use of an integral Stop End. Retrofit Stop Ends can be fitted to Keyfix NCCT using a proprietary butyl mastic.

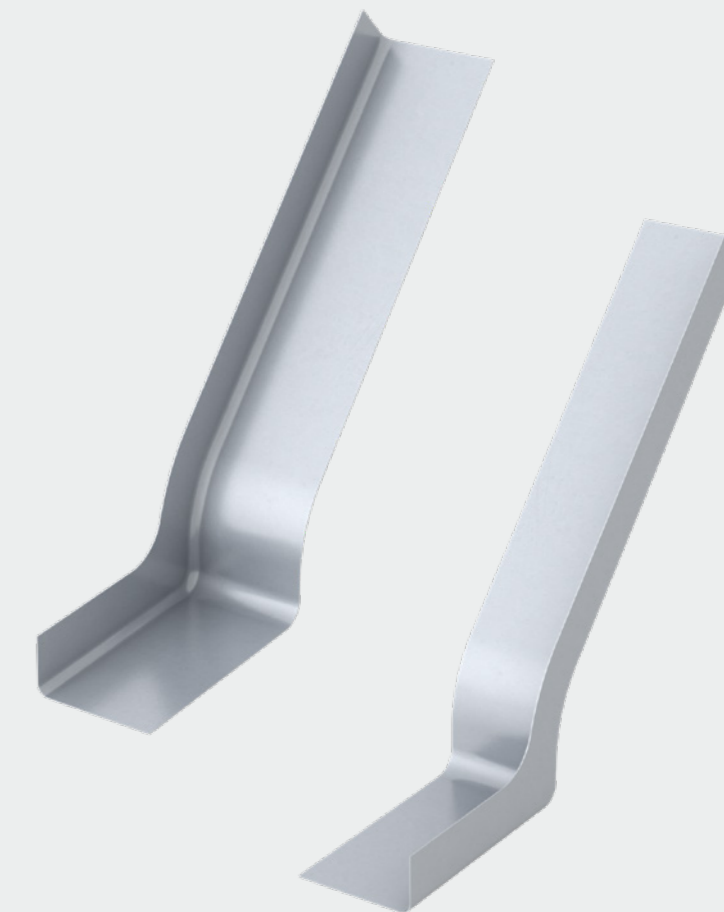

Reading Component Schedule and Location Mark-up

Keyfix provide a full design and scheduling service for each project which includes itemised Component Schedules ❶ and Location Mark-Ups. ❷

Component Schedules and Location Mark-Ups show the locations of Keyfix Non-combustible Cavity Tray components on architect's floor plan drawings.

Each Keyfix NCCT component is delivered with a pre-fitted component label, which contains part identification that matches the itemised Component Schedule. This ensures that the correct NCCT components are installed in the correct location and therefore allows quicker installation by removing any onsite design decisions.



Components highlighted in blue in Component Schedule represent welded Corner Units.

Components not highlighted represent non-welded components such as Brick Trays, Jointing Pieces, Stepped Capping Pieces etc.

Component Schedule ❶

		Key						
		Welded Component						
		Non-Welded Component						
LOCATION								
BLUE CIRCLES	1	RL550	55ORR					
		4BT	JP	4BT				
	2	RL550	55ORR					
		4BT	JP	4BT	JP	4BT	JP	4BT
	3	RL550	55ORR					
		4BT	JP	4BT				
	4	RL550	55ORR					
		4BT	JP	4BT	JP	4BT	JP	4BT

Location Plan Mark-up ❷

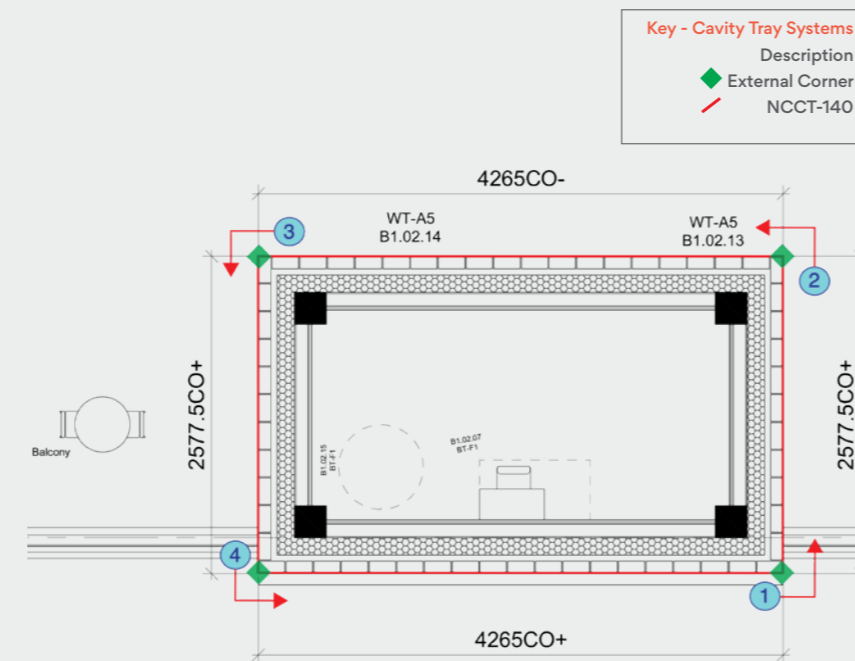

Reading Component Schedule and Location Mark-up

Starting at a corner and proceeding anti-clockwise, the adjacent Component Schedule ❶ reads, "RL550 x 55ORR" which is a welded Corner Unit. The following line within Component Schedule reads, "4BT JP 4BT" indicating that two Brick Trays are to be joined together by a Jointing Piece.

These Components are to be installed at Location 1, which is represented as a Blue Circle on the Location Mark-up. ❷

Component Schedule

		Key						
		Welded Component						
		Non-Welded Component						
LOCATION								
BLUE CIRCLES	1	RL550	55ORR					
		4BT	JP	4BT				
	2	RL550	55ORR					
		4BT	JP	4BT	JP	4BT	JP	4BT

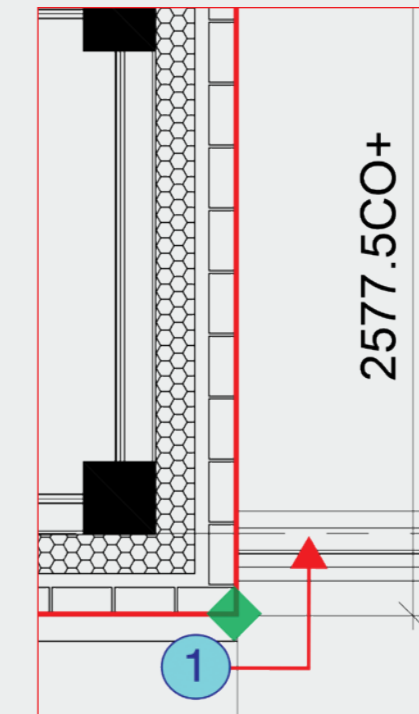

Location Plan Mark-up ❷

Key - Cavity Tray Systems	
Description	
◆	External Corner
—	NCCT-140



keyfix.com

NCCT Installation Guide



Watch Keyfix NCCT Install here

Keyfix

Fix + Forget

Designed for rapid build, the Keyfix NCCT is a 'Fix + Forget' self-supporting, single piece tray that clicks together for fast, easy, efficient installation.

No additional fixings, sealants or fabrication are required so installation of the trays will not impede the speed of brick laying when compared to any traditional DPC.

The Keyfix Technical Team provide a full take-off, design and scheduling service which includes itemised component schedules and component location mark-up services to overcome and eliminate any possible onsite design decisions and installation errors.

keyfix.com

WARNING! Potential Sharp Edges – Cut Level 5 Gloves Must Be Worn

Cavity Tray Location

Cavity Trays should be installed as close as possible to item being protected or within a max. of 225mm vertically.

Cavity Trays should, where possible, conform to the minimum geometry set out in the diagram below.

Where a Cavity Tray cannot achieve minimum 'geometry', additional attention should be given to reducing moisture and mortar droppings by providing additional trays above.

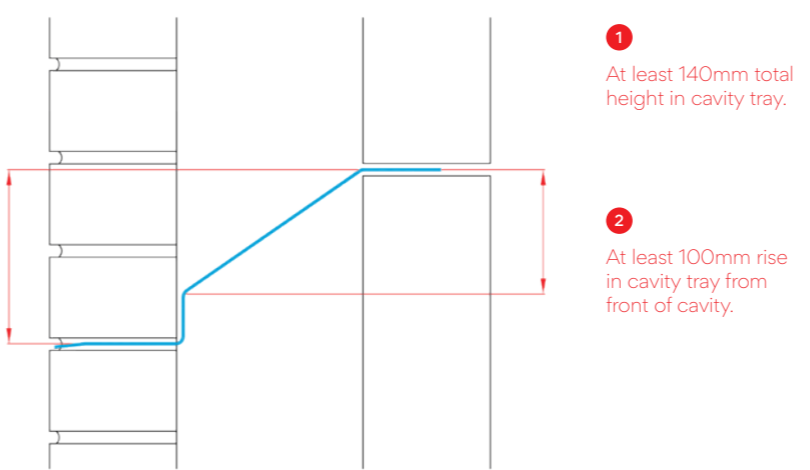

NB: Keyfix NCCT System is deemed to be rigid enough to be self-supporting and therefore does not need support from the internal skin.

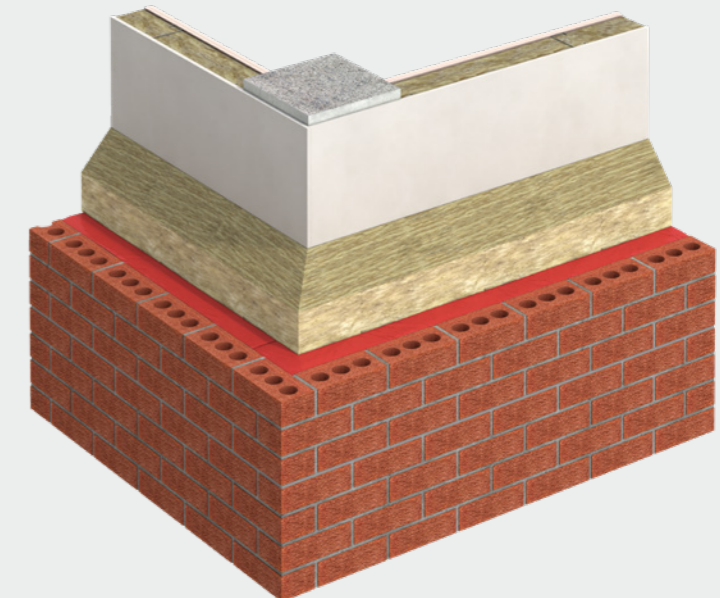
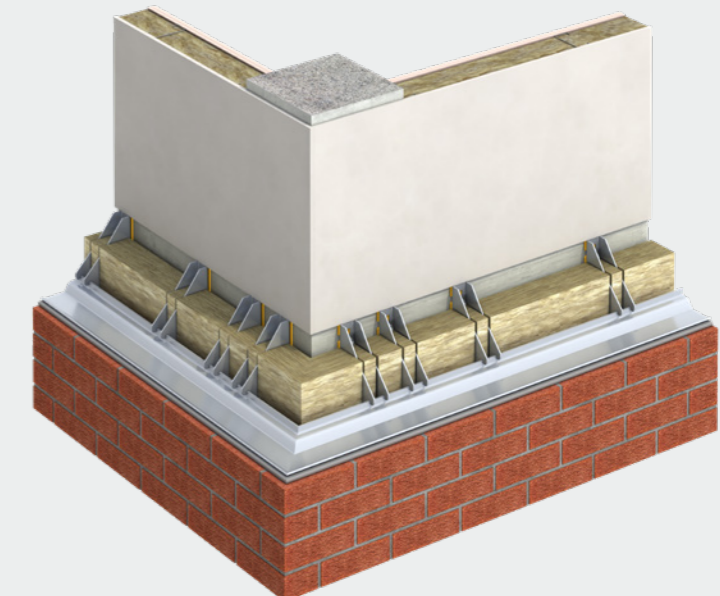

Dry-Fit Cavity Trays

When ready to install Keyfix NCCT, start at a corner indicated on Location Mark-up.

Before laying mortar, it is considered good practice to set out and assemble Keyfix NCCT components on top of brickwork. This allows easy adjustments between Corner Unit and overlapping Brick Trays before wet mortar is applied. Easy adjustment between components ensures:

- ✓ Sufficient overlap between Corner Unit Ribbed End and Brick Tray.
- ✓ Brick Tray Stop Ends correctly align within perp joints prior to applying mortar.

Once final adjustments are made, the installer can fix the Brick Tray to the Corner Unit at the top with Split Pins supplied.



Start at corner, place ½ bed of mortar below Corner Unit and first Brick Tray.



WARNING! Potential Sharp Edges – Cut Level 5 Gloves Must Be Worn

Mortar Bed for Corner Unit

When adjustments have been made, lift assembled trays and place half bed of mortar below and ensure:

- ✓ Corner Unit is well bedded (pushed down) into mortar, ensuring no gaps between Ribbed End and mortar bed.
- ✓ Outside leading edge of Corner Unit is installed 10mm from outside edge of brickwork.
- ✓ Ensure Ribbed Ends are kept clear of any mortar.

It is critical to ensure an adequate mortar bed is placed below Cavity Trays to ensure sufficient adhesion between brickwork and trays. Achieving good adhesion between these elements:

- ✓ Eliminates the risk of slip plane.
- ✓ Eliminates moisture ingress via capillary action.
- ✓ Ensures 10mm joint thickness is maintained when Brick Trays are overlapped at Ribbed Ends.

It is also critical to ensure that the Ribbed End is clear of mortar to ensure sufficient drainage. In the event of high volume of water being captured on a Corner Unit, the Secondary Weep Vents created when Brick Trays overlap the Ribbed Ends, allow excess moisture to drain off of the Cavity Tray and out of the building.

*Brick Trays hidden from Figure 4 and Figure 5 for clarity

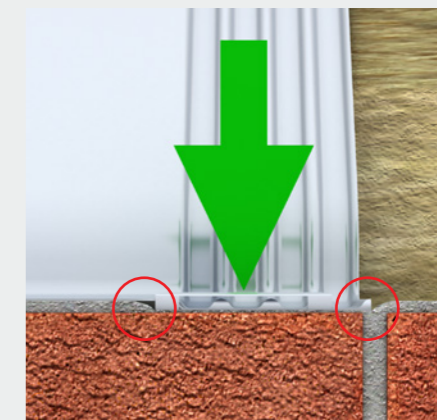
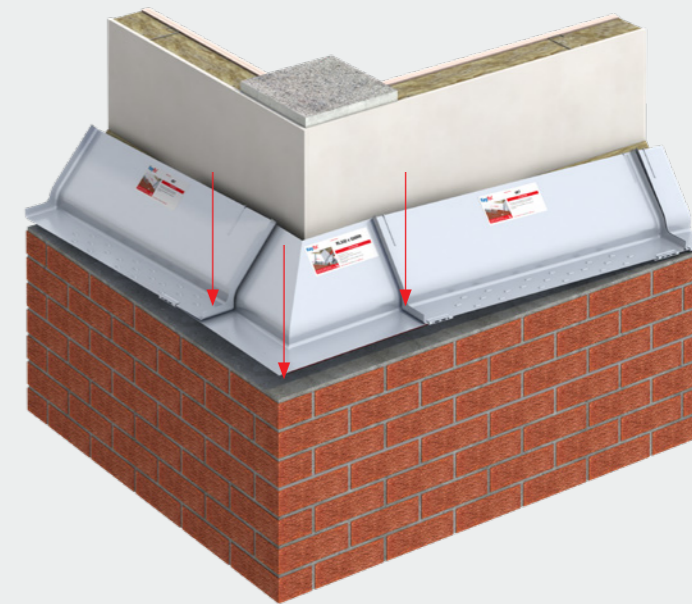

Figure 4

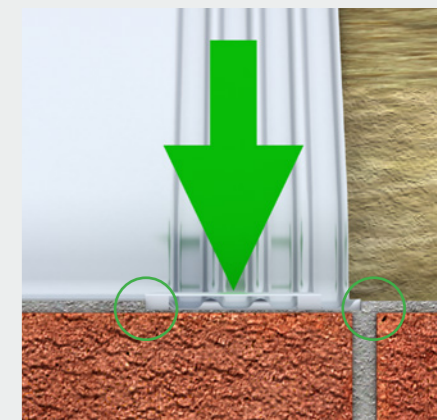

Figure 5



Place Corner Unit on half bed of mortar.

Connecting Brick Tray to Jointing Piece

Assemble Jointing Piece **1** onto first Brick Tray by inserting Brick Tray **2** into pre-installed Lower Clip on front edge of Jointing Piece and secure at top edge with first Split Pin.

Repeat process with second Brick Tray **5** and secure with second Split Pin. **6**

Brick Tray Stop End must meet midway between Ribbed End sections on Jointing Piece. Therefore, each Ribbed End section on Jointing Piece, must be covered by overlapping Brick Tray's. **7**

Perp joint width adjustment can be achieved by sliding Brick Trays left or right within Lower Clip.

Ensure perp joint is fully filled with mortar between and on top of Stop Ends between abutting Brick Trays.



Assemble Jointing Piece onto end of first Brick Tray by inserting into Lower Clip, then securing with Split Pin.

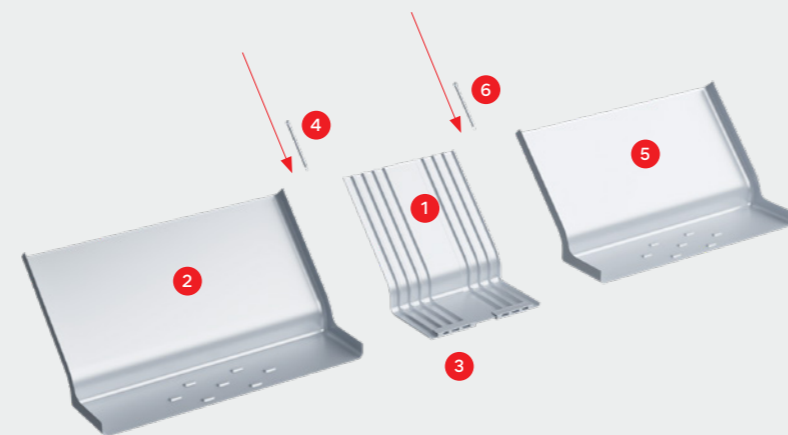

- 1** Jointing Piece
- 2** First Brick Tray
- 3** Lower Clip
- 4** First Split Pin
- 5** Second Brick Tray
- 6** Second Split Pin
- 7** Overlapping Brick Trays

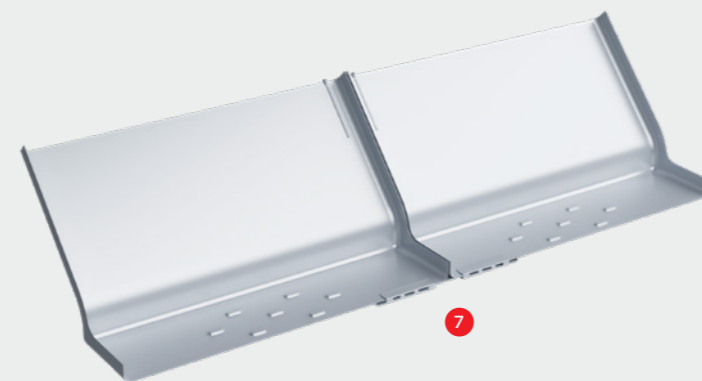

WARNING! Potential Sharp Edges – Cut Level 5 Gloves Must Be Worn

Locating Brick Trays on Corner Unit

Ensure first Brick Tray is located within the pre-installed Lower Clip on a Ribbed End Corner Unit. **1**

Ensure overlapping Brick Tray is secured within Corner Unit by checking leading edge of Brick Tray is aligned with the leading edge of Corner Unit.

Brick Tray must overlap Ribbed End as a minimum. **2**

This achieves a minimum overlap of ½ Brick. Keyfix NCCT External and Internal Corner Units are sized to allow Brick Tray to overlap minimum of ½ Brick to a maximum of 1½ Bricks, allowing adjustability to match coursing onsite.



Locate Brick Tray into Lower Clip located on front leading edge of Corner Unit. Overlap Corner Unit with Brick Tray by minimum of ½ Brick and secure with Split Pin.

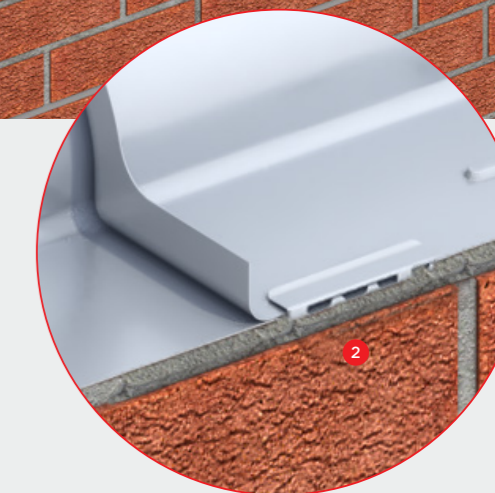

'Buttered Up' Stop End

Place half Bed of mortar on top of Corner Unit. ①

Outside of Brick Tray integral Stop Ends **must be 'Buttered-Up' with mortar.** ②

This restricts the free flow of moisture towards Ribbed End and encourages excess moisture to drain via Weep Vents by following path of least resistance. ③

When installing Pier Units, ensure any space between end of brick installed on top of Corner Unit and Stop End is 'Buttered Up' and fully filled with mortar.

This obstructs passage of moisture and encourages moisture to follow path of least resistance and drain via Weep Vents.



For overlapping Brick Tray, outside of integral Stop Ends must be 'Buttered Up'. For Pier Units, inside of integral Stop Ends must be 'Buttered Up'.

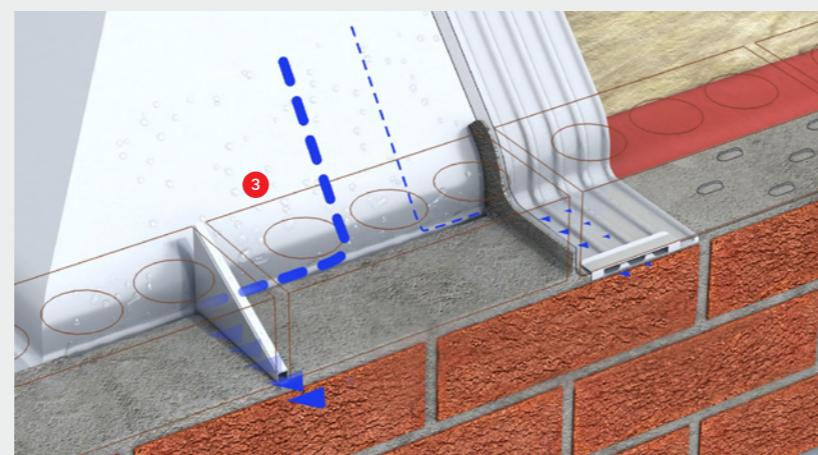
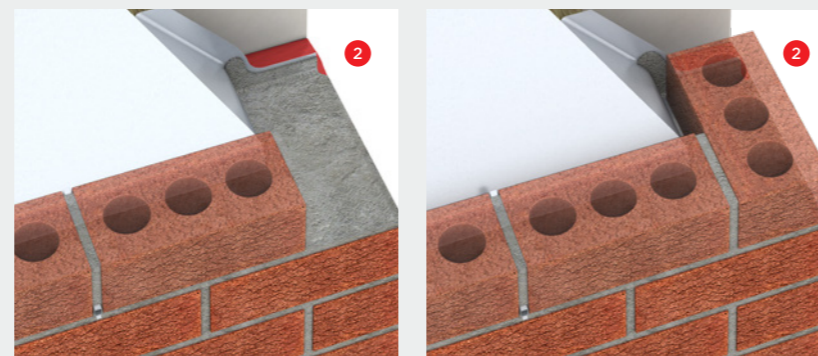

WARNING! Potential Sharp Edges – Cut Level 5 Gloves Must Be Worn

Weep Placement on Corner Unit

Keyfix Non-combustible Stainless Steel Weep should be placed within 225mm from outside of 'Buttered Up' Brick Tray Stop End. ①

A minimum of two Weeps are required per corner to provide sufficient drainage.

Only Stainless Steel Weeps can be used directly on top of Stainless Steel Cavity Trays to avoid bi-metallic / electrolytic corrosion between dissimilar materials.

Zinc plated weeps must be placed on top of mortar bed to avoid bi-metallic / electrolytic corrosion between dissimilar materials.



Ensure Secondary Weep Vents remain clear from mortar. Use Banding Strap to check and clear any mortar.

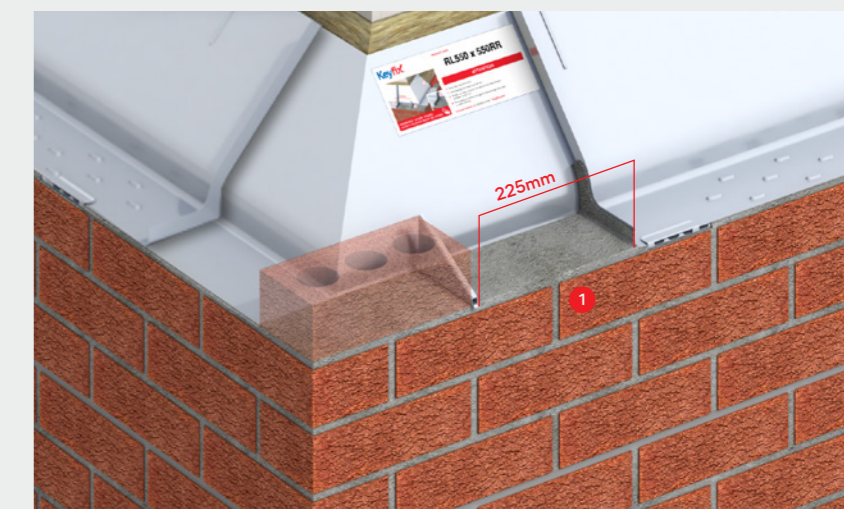
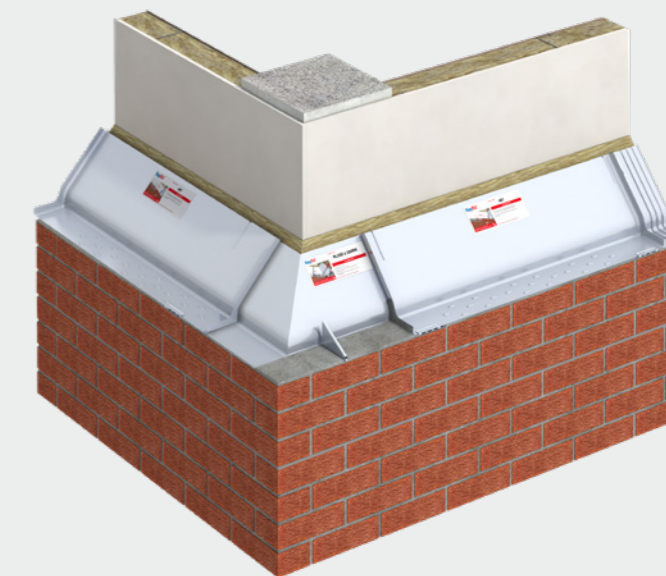

Bedding Mortar on Brick Tray

Place half bed of mortar on top of trays and commence brickwork. **1**

After locating Weep within 225mm from outside of 'Buttered Up' Brick Tray Stop End, Weeps are placed at a maximum spacing of 900mm c/c with a minimum of one weep required on each Brick Tray. **2**

Ensure Perp Joints with Weep Vents and Brick Tray Stop Ends are fully filled with mortar. **3**

It is good practice to use a wooden lath **4** or hessian mesh behind brickwork to catch mortar droppings. This can be periodically cleaned, raised and repositioned as brickwork progresses.



Commence brickwork over Corner Unit and first Brick Tray.
Ensure Weeps are placed within maximum spacing of 900mm c/c.

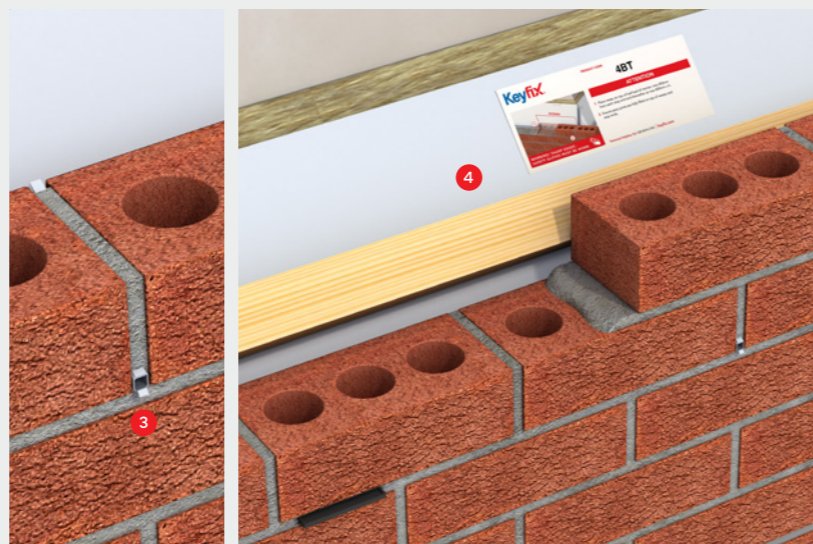

WARNING! Potential Sharp Edges – Cut Level 5 Gloves Must Be Worn

Ribbed Connections on Corner Unit

When a Brick Tray overlaps a Ribbed End on Corner Unit, this creates a Secondary Weep Vent at locations of Lower Clips, which allows any moisture that soaks through the 'Buttered Up' Stop End to escape. **1**

It is critical to ensure that Secondary Weep Vents at these locations remain clear of mortar to provide efficient drainage in the event of high volume of moisture on top of Corner units.

After pointing up mortar, it is good practice to use a banding strap to check and remove any remaining mortar from Secondary Weep Vents. **2**



Ensure Secondary Weep Vents remain clear from mortar.
Use Banding Strap to check and clear any mortar.

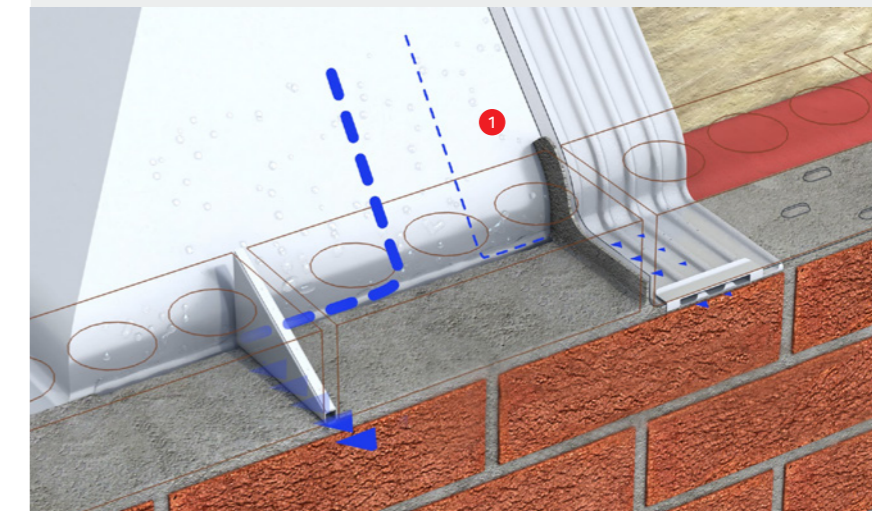

Continue Brickwork Around Perimeter of Building

Cavity Trays should be installed as per previous instructions within Keyfix Component Schedule and Location 'Mark-Up' before returning to the start point. 1

After half bed of mortar is placed on top of Corner Unit and overlapping Brick Tray, ensure outside of Brick Tray Stop End is 'Buttered Up'. 2

Place Weep on Corner Unit within 225mm from outside of 'Buttered Up' Brick Tray Stop End and within maximum of 900mm c/c. 3

Ensure minimum of two Weeps are placed on each Corner Unit and minimum of one Weep on each Brick Tray. 4



Continue brickwork around the building as per previous instructions. Ensure outside of Brick Tray Stop End is 'Buttered Up'.

Ensure minimum Weep installation requirements are followed.

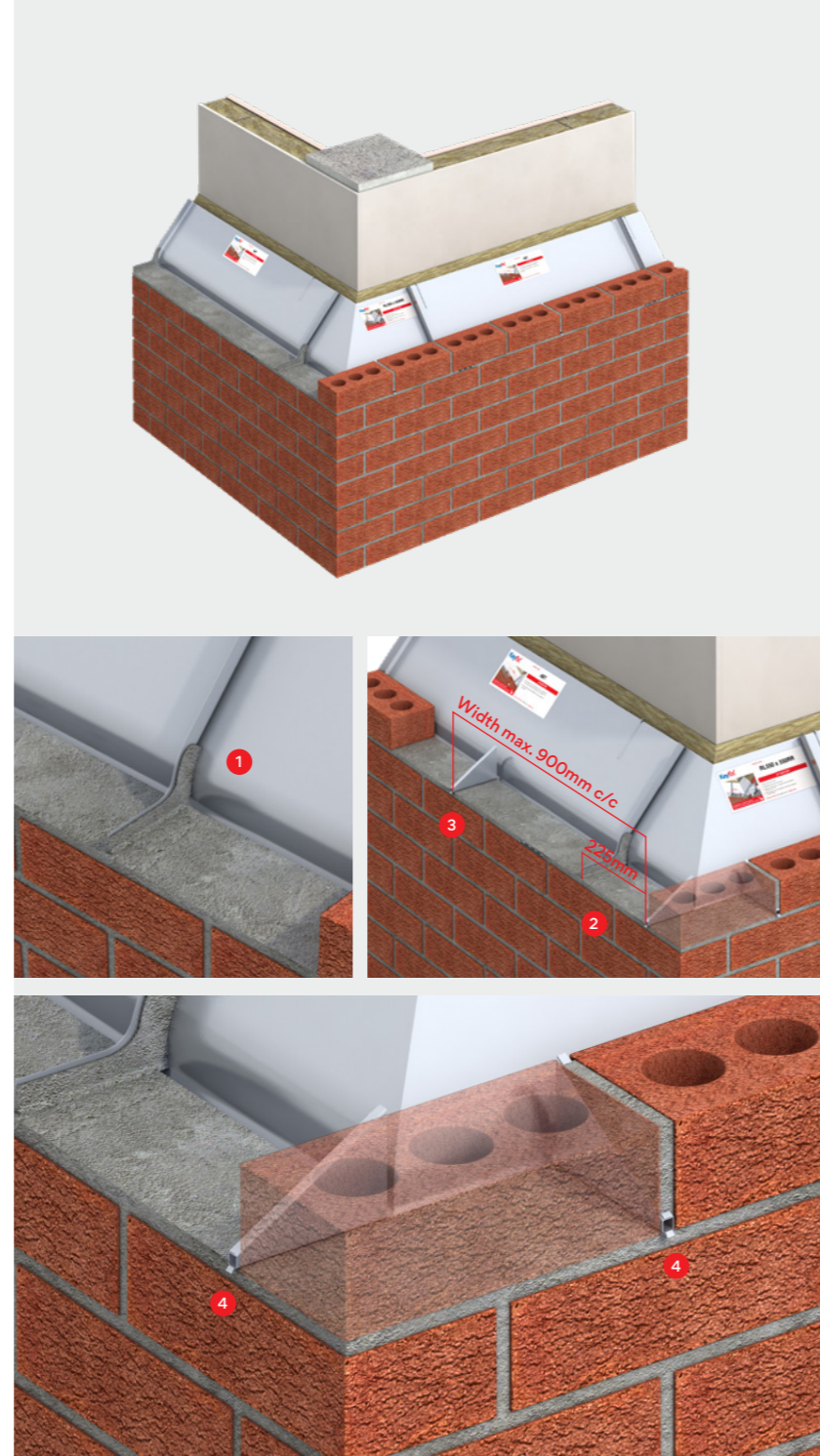

WARNING! Potential Sharp Edges – Cut Level 5 Gloves Must Be Worn

Membrane Overlap

Once brickwork over Cavity Trays is installed, it is considered good practice to fold over the corners of the integral Stop Ends to avoid any sharp edges fouling the membrane. 1

Advice from Warranty Providers indicates that it is good practice to install a local strip of membrane over the space between the Cavity Tray and the internal skin. 2

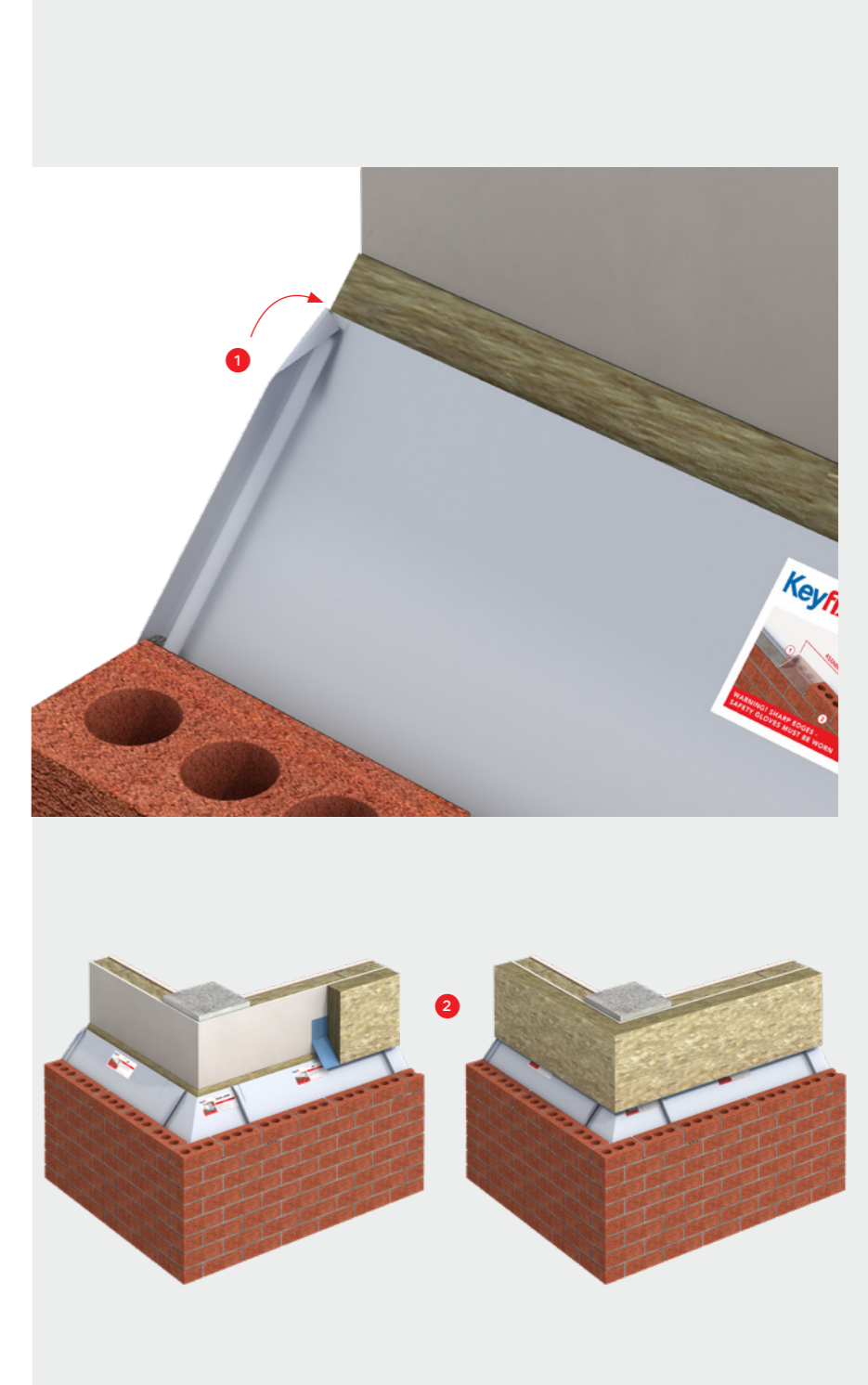



Keyfix Limited NI

Ballyreagh Industrial Estate
Sandholes Road
Cookstown
BT80 9DG

Keyfix Limited GB

Ryder Close
Cadley Hill Industrial Estate
Swadlincote
DE11 9EU

T +44 (0)28 8676 7508
E info@keyfix.com



Watch Keyfix NCCCT Install here

keyfix.com