

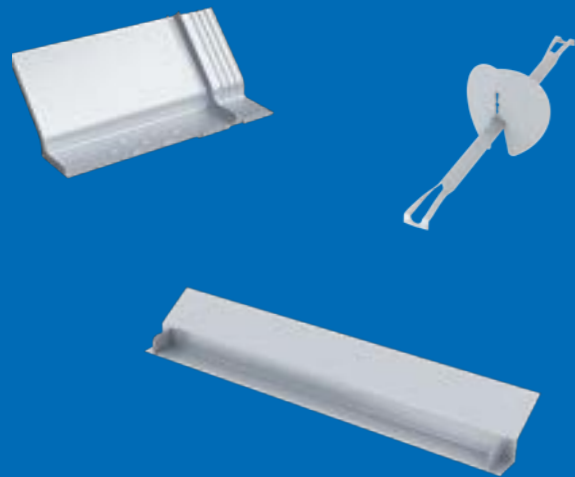

Innovative
Non-combustible
Cavity Tray Solutions

Innovative Non-combustible Solutions



Contents

Introduction	06
Document B Compliance	10

NCCT

Non-combustible Cavity Tray System

Non-combustible Cavity Tray System	12
Fix + Forget	14
NCCT Specification	16
NCCT Components	20
NCCT Installation Guide	28
NCCT Technical Guidance	42
Non-combustible Retaining Disc	56

NCCTL

Non-combustible Cavity Tray Lintel

Non-combustible Cavity Tray Lintel	60
Cavity Tray Requirements	62
NCCTL Specification	66
NCCTL Installation Guide	74

The next big thing

Innovative Non-combustible Solutions



Keyfix, part of the Keystone Group of companies, specialises in the development of masonry accessories including builder's metal work and fixings. Synergising 30+ years of Keystone experience in structural steel including lintels and masonry support, Keyfix fills the gap to provide the complete non-combustible solution for the external cavity.

John Duffin
Managing Director



Suitable for projects
over 18m in height.



Keyfix is setting new standards in the delivery of non-combustible (NC) cavity systems for projects requiring Document B compliance in buildings over 18m high utilising steel frame systems in the external cavity.



Document B Compliance

In response to incidents involving the spread of fire within external cavities on tall buildings, the Building Regulations have been updated to prohibit the use of combustible materials within the external cavities of buildings over 18m in height. The regulations apply to buildings containing one or more dwellings; an institution; or a room for residential purposes (excluding any room in a hostel, hotel or boarding house, but including student accommodation, care homes, sheltered housing, hospitals and dormitories in boarding schools.)

The amendments to the Approved Documents provide the further guidance (12.10 Note 2) that 'materials achieving limited combustibility cannot be deemed to meet the requirement using an alternative classification method'.

Responding to the increasing requirement for non-combustible A1 fire rated components in compliance to Building Regulations Document B, Keyfix has introduced the following solutions to its ever growing cavity protection portfolio.

Non-combustible
**Doc B
Compliant**



NCCT
Non-combustible
Cavity Tray System

Non-combustible
**Doc B
Compliant**



NCCTL
Non-combustible
Cavity Tray Lintel

Non-combustible
**Doc B
Compliant**



NCRD
Non-combustible
Retaining Disc

Setting New Standards

NCCT

Non-combustible Cavity Tray System

Keyfix is setting new standards in the delivery of non-combustible cavity systems for projects requiring Document B compliance. In buildings utilising steel frame systems in the external cavity, the innovative Keyfix Non-combustible Cavity Tray System is a practical solution to provide protection over lintels, masonry supports, soffit systems and other elements in the cavity such as fire barriers.

- ✓ Self-supporting.
- ✓ No sealants required.
- ✓ Bond / coursing adjustability.
- ✓ Integral Stop Ends.
- ✓ Available for all cavity configurations.
- ✓ No Thermal Bridging.

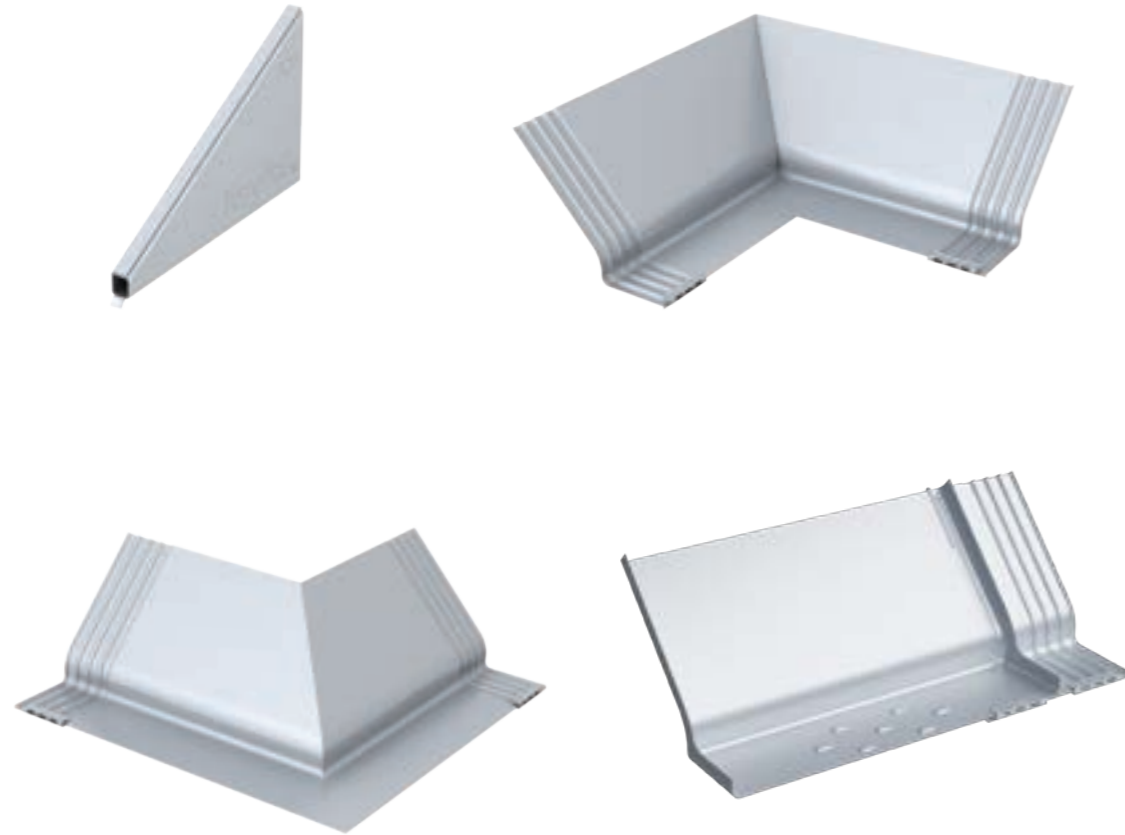

NCCT Non-combustible Cavity Tray System

Fix

+ Forget

Designed for rapid build, the Keyfix NCCT is a 'Fix + Forget' self-supporting, single piece tray that clicks together for fast, easy, single handed installation. No additional fixings, sealants or fabrication are required so installation of the trays will not impede the speed of brick laying when compared to any traditional DPC.

Design Scheduling Service

The Keyfix Technical Team provide a full design scheduling and component location package to overcome and eliminate any possible onsite installation errors in onsite design decisions.



Manufactured
entirely from A1 fire
rated stainless steel



Suitable for
Cavities >50mm

NCCT Specification

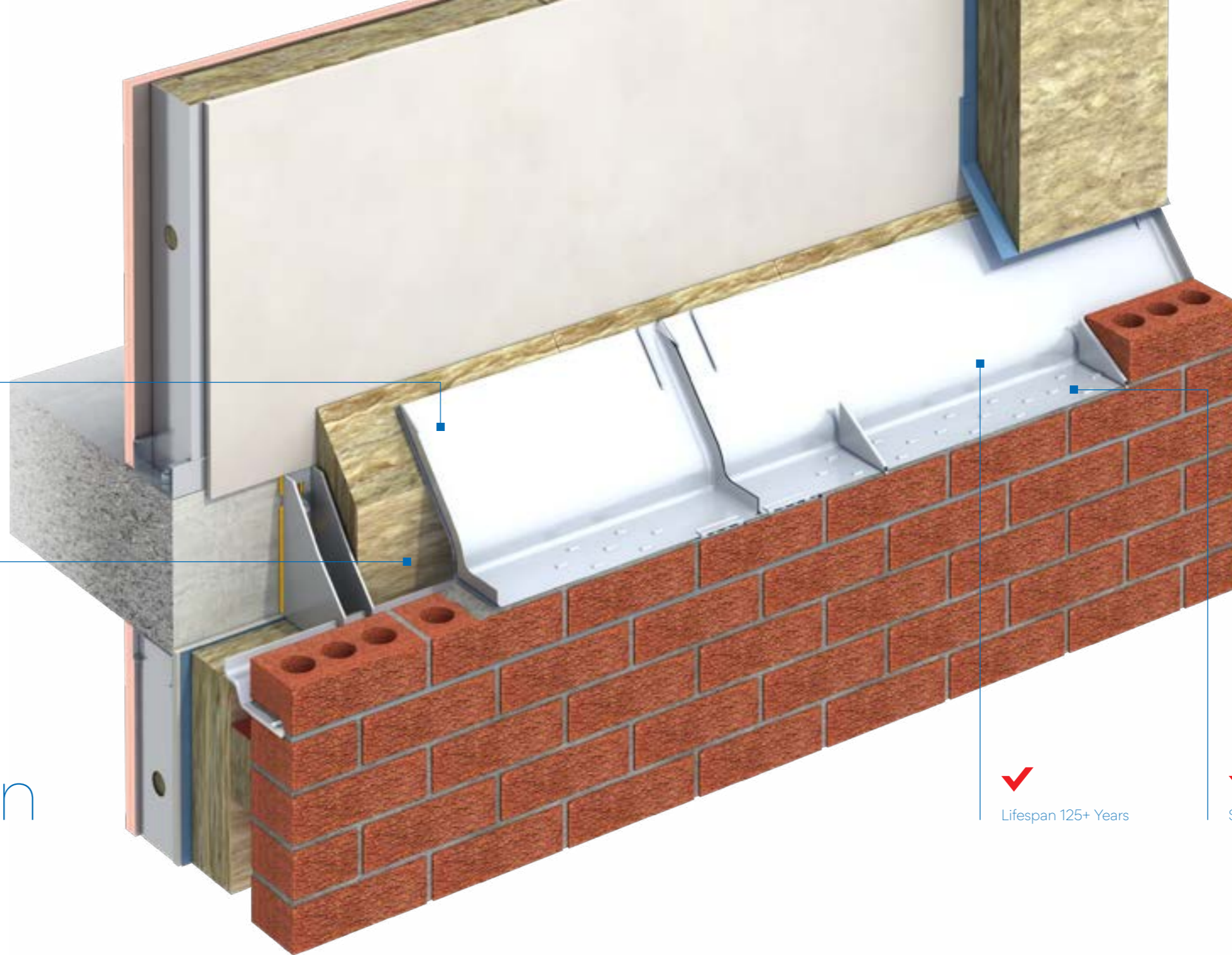

Lifespan 125+ Years



Slip Plane Resistance

Why Specify Keyfix NCCT?

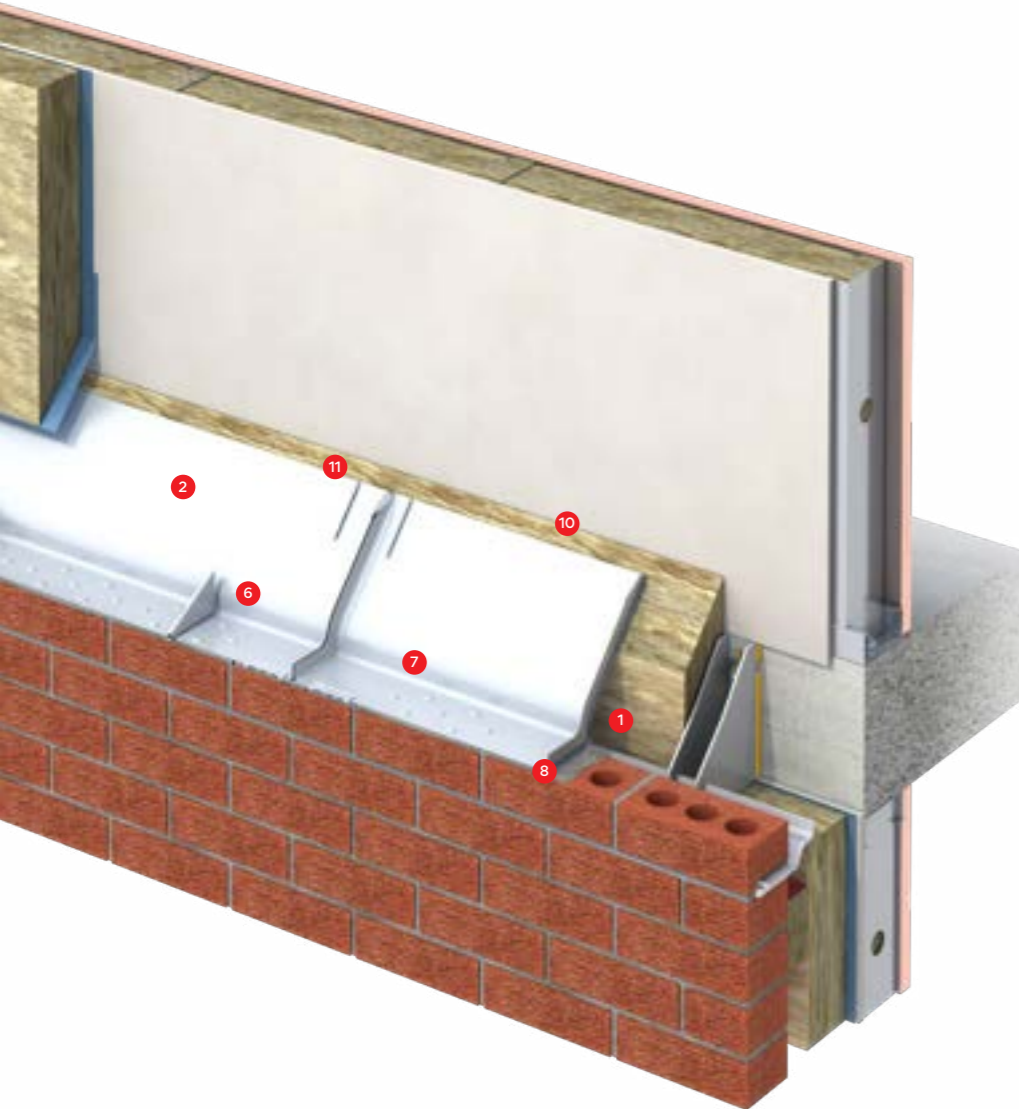

1 Suitable for Cavities >50mm

To meet the high degree of variation of cavity widths used within a building the Keyfix NCCT is available to suit cavities from 50mm wide. Contact Keyfix Technical Team for other cavity sizes.

2 Rigid Self Support

The rigid stainless steel tray is self-supporting across the cavity enabling the bricklayer to install the trays without assistance.

3 Classified A1 Fire Rated

The system is manufactured entirely from Class A1 Non-combustible stainless steel, providing no contribution to fire and insignificant release of smoke, droplets or other particles.

4 Lifespan 125+ Years

Manufactured as standard using high quality 0.5mm Grade 304 austenitic stainless steel assures longevity of service. For coastal locations Grade 316 austenitic stainless steel should be specified to ensure compliance with relevant British Standards and Warranty Provider requirements.



5 Slip Plane Resistance

The lower horizontal 'flange' of the NCCT incorporates a patented indented surface providing a physical key within the mortar bed. This eliminates the risk of slip plane developing within the masonry outer skin.

It is also essential that a tray has no perforations to prevent rising damp.

6 Non-combustible Weeps

The Keyfix Non-combustible Weep is manufactured from Grade 304 Stainless Steel which holds an A1 non-combustible Fire Rating. Its unique design compliments the Keyfix NCCT Systems for perp joint adjustability, but can equally be installed over any stainless steel component, such as Lintels or Masonry Support.

7 Requires no Sealants or Mastics

The Keyfix NCCT is the only Cavity Tray of its type on the market with a mechanical dry seal at joints. By eliminating the use of any sealants at joints we have removed the possibility of installation errors caused by onsite conditions.

8 Integral Stop Ends

Keyfix NCCT incorporates an integral Stop End to ensure water is trapped and channelled outwards at each tray. The integral Stop Ends also provide joint width adjustability of ± 3 mm between 7-13mm if required.



9 Bond Friendly Adjustable Corners

The system includes prefabricated 90° internal and external corner units which facilitate a continuous run without the need for onsite cutting or fabrication. Bespoke corner angles are available to order. Ribbed joints on corner units provide bond /coursing adjustability.

10 No Thermal Bridge

Completely self-supporting, the Keyfix NCCT is installed in the outer leaf with no connection whatsoever with the inner skin and therefore does not create a thermal bridge.

11 Zero Differential Movement

With installation completely independent from the inner leaf there is zero possibility of differential movement with the Keyfix NCCT system.

12 Onsite Simplicity

The system eliminates the need for onsite fabrication. Itemised component schedules and location plans ensure easy ordering and installation with stock available quickly via our extensive distribution network.



NCCT Components

BT Brick Trays

Brick Trays are modular units that are fabricated to suit brick coursing. Keyfix fabricate trays in half brick increments from a 1 Brick Tray to a 10 Brick Tray.



Coding Explained

Brick trays are coded regarding the run of brick that will be built in to them i.e.

1BT	1.5BT	2BT	2.5BT	3BT
1 Brick Tray	1.5 Brick Tray	2 Brick Tray	2.5 Brick Tray	3 Brick Tray

Corner Units

Corner units are required on every project in order for the Non-combustible Cavity Tray System to continue around corners on a building or at a brick return reveal.

RL 550 x 550 RR
External Corner Unit

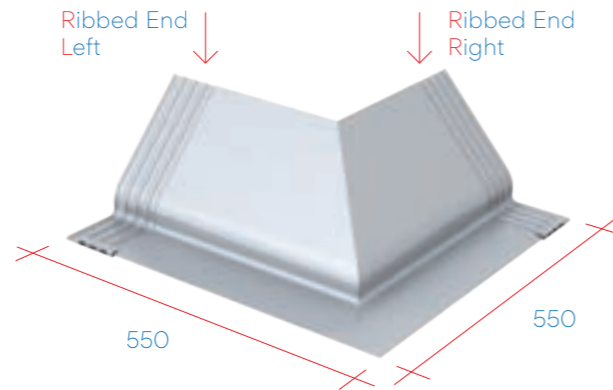

Reveal Corner

A 'reveal corner' is used when brickwork is returned around to recess into a window sill or door.

RL 550 x 205 SR
Left Handed Corner Unit

SL 205 x 550 RR
Right Handed Corner Unit

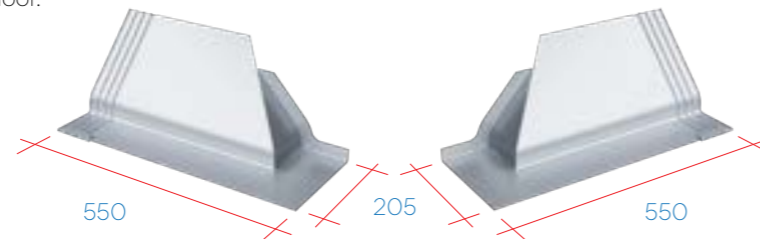

Ribbed Overlapping Joints

Ribs formed by downward pressed channels within the tray profile are an essential component of the Keyfix NCCT system. The preformed ribbed overlapping joint eliminates the use of any sealants, mastics or tapes at joints. Thus giving unrivalled joint integrity lifespan and removes all installation errors associated with onsite conditions such as dust, moisture or low temperatures which can prevent 'wet' joints performing, resulting in water ingress.

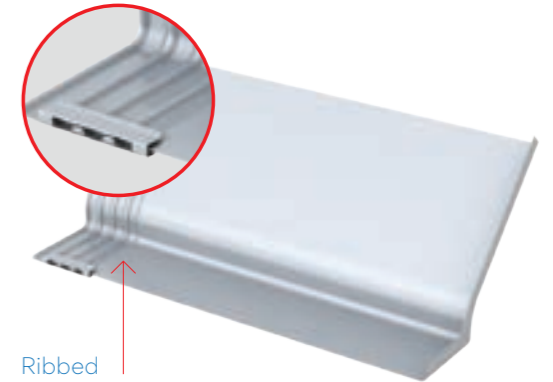

Ribbed
Overlapping Joint

The unit is coded from left to right, when viewed from the outside. Firstly describing if a Stop End or Ribbed End occurs, then stating the leading dimensions. Units are then closed out by again stating any Stop End or Ribbed End.

The adjacent unit is described as:
RL 450i x i450 RR
Internal Corner Unit

- Ribbed End to the LHS
- First leading dimension is 450mm.
- The unit then has an internal corner, (i).
- Second leading dimension is 450mm.
- The unit is closed with a Ribbed End to the RHS.

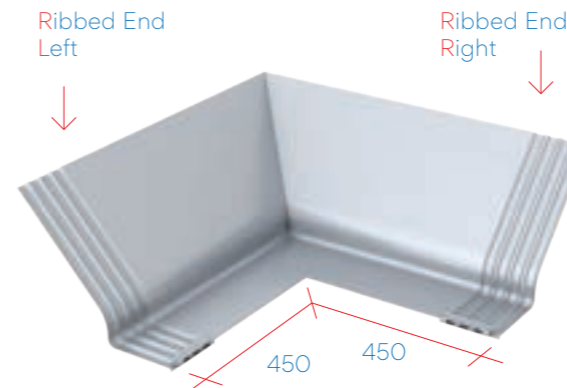

Technical Note

External Corner Units have a leading dimension of at least 550mm on either side. Internal Corner Units have a leading dimension of at least 450mm on either side. This is to allow for overlapping of the adjoining brick tray. The brick tray can overlap minimum of 1/2 Brick to a max 1 1/2 Bricks, allowing to match coursing onsite.

Pier Units

Pier Units are fabricated bespoke depending on project requirements so one single Non-combustible Cavity Tray piece can be used in congested locations. Such as an 890 pier between two openings.

The unit is coded from left to right, when viewed from the outside. Firstly describing if a Stop End or Ribbed End occurs, then stating the leading dimensions. Units are then closed out by again stating any Stop End or Ribbed End.

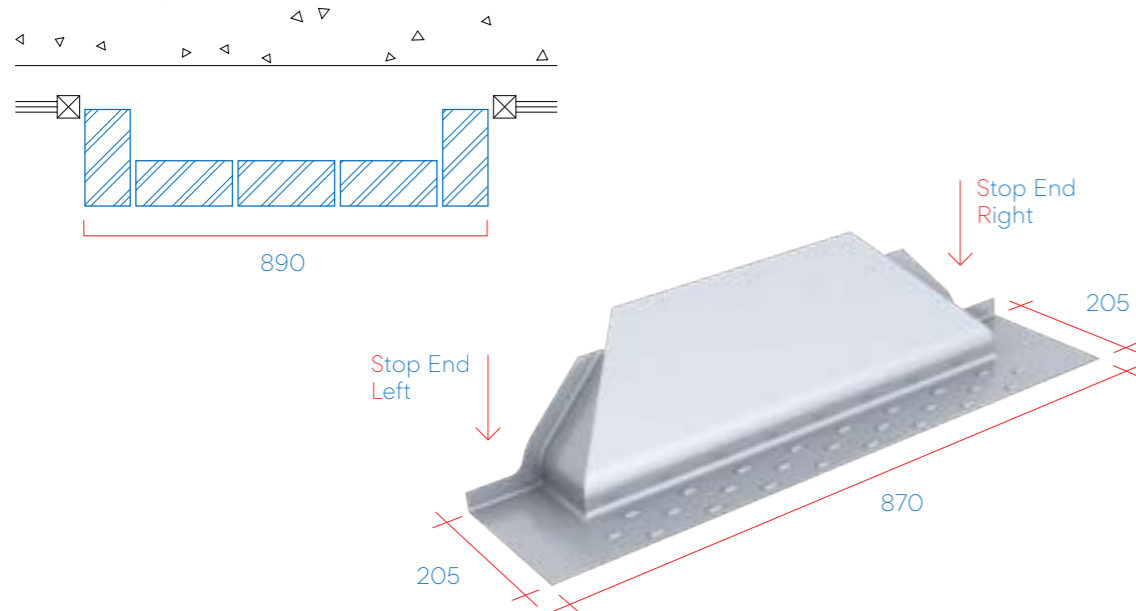

The unit below is described as:

SL 205 x 870 x 205 SR

- Stop End to the LHS
- First leading dimension is 205mm.
- The unit then has an external corner (x).
- Second leading dimension is 870mm.
- Followed by a second external corner (x).
- Third leading dimension is then 205mm.
- The unit is closed with a Stop End to the RHS.



JP Jointing Piece

A Jointing Piece is used to join together two abutting Brick Trays where the Stop Ends abut each other. The Joint Piece is then used to clip both trays together and provides an underlap that will drain any moisture present, between both Stop Ends. The perp joint between two abutting Brick Tray Stop Ends must be fully filled with mortar.

SCP Stepped Capping Piece

A Stepped Capping Piece is utilized when a Jointing Piece cannot be used because of a step in the panel of brickwork. By placing a Stepped Capping Piece over the top of the abutting Brick Tray Stop Ends, this allows the NCCT system to remain continuous over a run of brickwork while also accommodating the step in brickwork.

It is critical that the perp joint between abutting Brick Tray Stop Ends must be fully filled between and on top of Stop Ends before placing Stepped Capping Piece over the top of Stop Ends. The maximum allowable step in brickwork which can be accommodated is 50mm.



Outside of this range, a prefabricated corner unit must be considered.

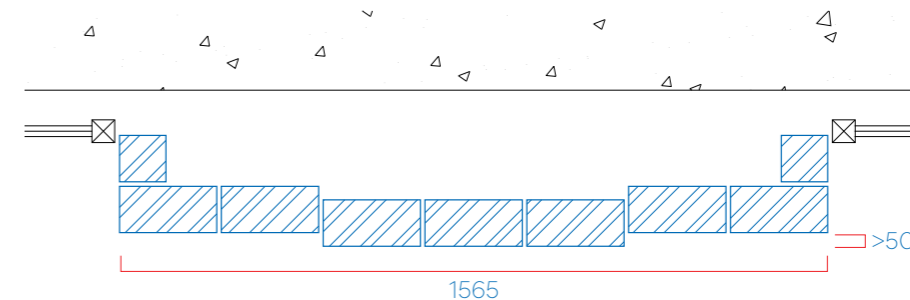

NCW Non-combustible Stainless Steel Weeps

The Keyfix Non-combustible Weep is manufactured from Grade 304 Stainless Steel which holds an A1 Non-combustible Fire Rating. Its unique design compliments the Keyfix NCCT Systems for perp joint adjustability, but can equally be installed over any stainless steel component, such as Lintels or Masonry Support. Unlike weeps manufactured from other metals, the Keyfix NCW will not suffer from electrolytic corrosion associated with the use of dissimilar metals in a wet environment in conjunction with stainless steel.

NCW's are available as 102mm & 215mm wide to satisfy all brickwork features.



NCDPC Non-combustible Stainless Steel Damp Proof Course

The Keyfix NCDPC range provides Document B compliant, Class A1 non-combustible Damp Proof Course protection. The Keyfix NCDPC provides no contribution to fire or significant release of smoke, droplets or other particles.





NCCT Installation Guide

01 Cavity Tray Location

Cavity Trays should be installed as close as possible to item being protected or within a max. of 225mm.

Cavity Trays should, where possible, conform to the minimum 'geometry' set out in the diagram below.

Where a Cavity Tray cannot achieve minimum 'geometry', additional attention should be given to reducing moisture and mortar droppings by providing additional trays above.

1

At least 140mm
total height in Cavity Tray.

2

At least 100mm rise in
cavity tray from front of cavity.

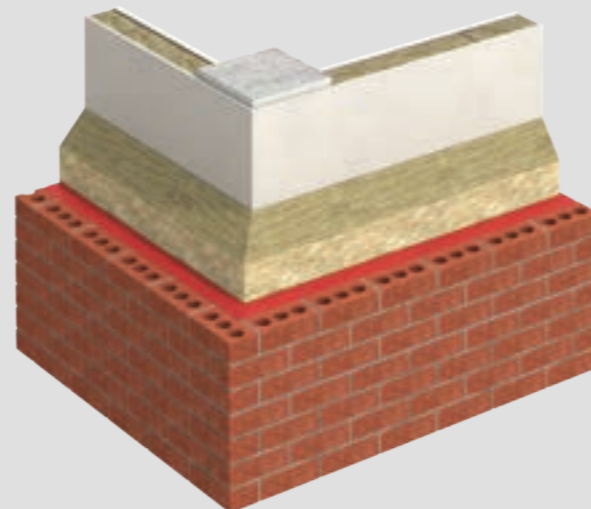
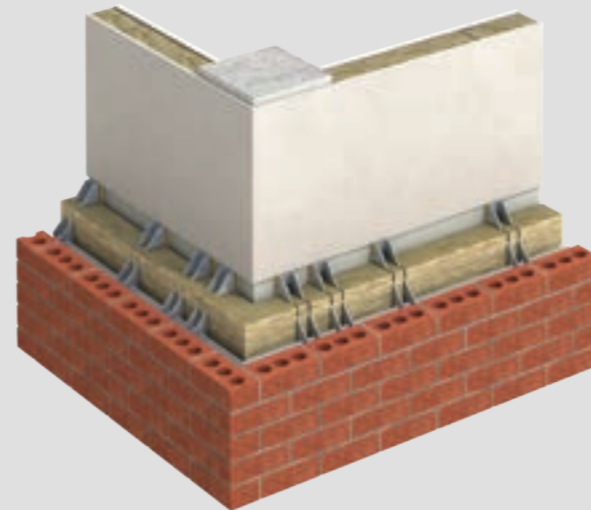
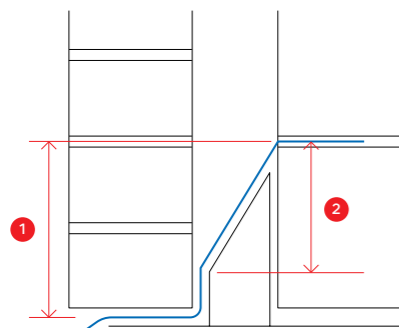

02 Mortar Bed for Trays

Dedicated mark-ups showing the location of itemised system components will be provided with the product. This ensures the correct product is being used in the correct location and avoids errors in onsite design decisions.

Before laying mortar, it is considered good practice to set out and assemble Keyfix NCCT components on brickwork. This allows all adjustments to be made before applying wet mortar and ensures Brick Tray Stop Ends align with perp joints prior to install.

Starting at a corner and proceeding in direction of mark-up, place half bed of mortar below corner and first trays.

Ensure adequate mortar bed is provided below trays and corners to ensure sufficient adhesion between lower brickwork and trays, which eliminates slip plane and moisture ingress via capillary action.



Start at corner, place ½ bed mortar below corner tray and first Brick Tray.

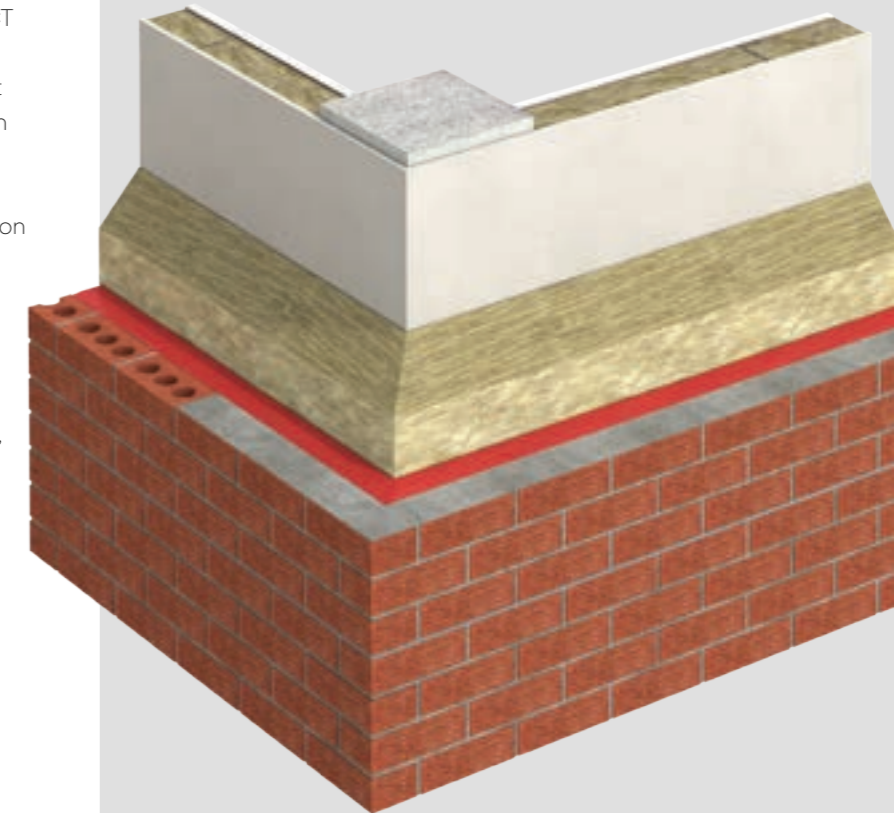

03 Placing Corner Unit

Place corner tray onto half bed and ensure it is well bedded (pushed down) into the mortar **1**. This ensures good adhesion between elements and ensures joint thickness over ribs is maintained, when overlapping Brick Tray is placed.

Ensure tray units align with outer edge of brickwork (or max. 10mm back) to facilitate good drainage **2**.

Ribs and clip act as secondary drainage weeps in the event of high volumes of water pooling on top of corner trays.

Area between ribs must be kept clear of mortar to allow excess moisture to drain off via the path of least resistance **3**.



Place corner tray on ½ bed of mortar ensuring front edge aligns with outside edge of brickwork.

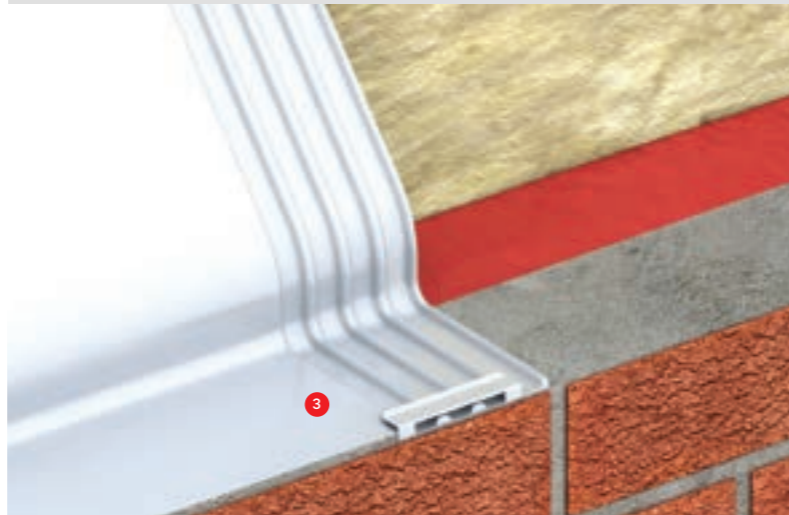
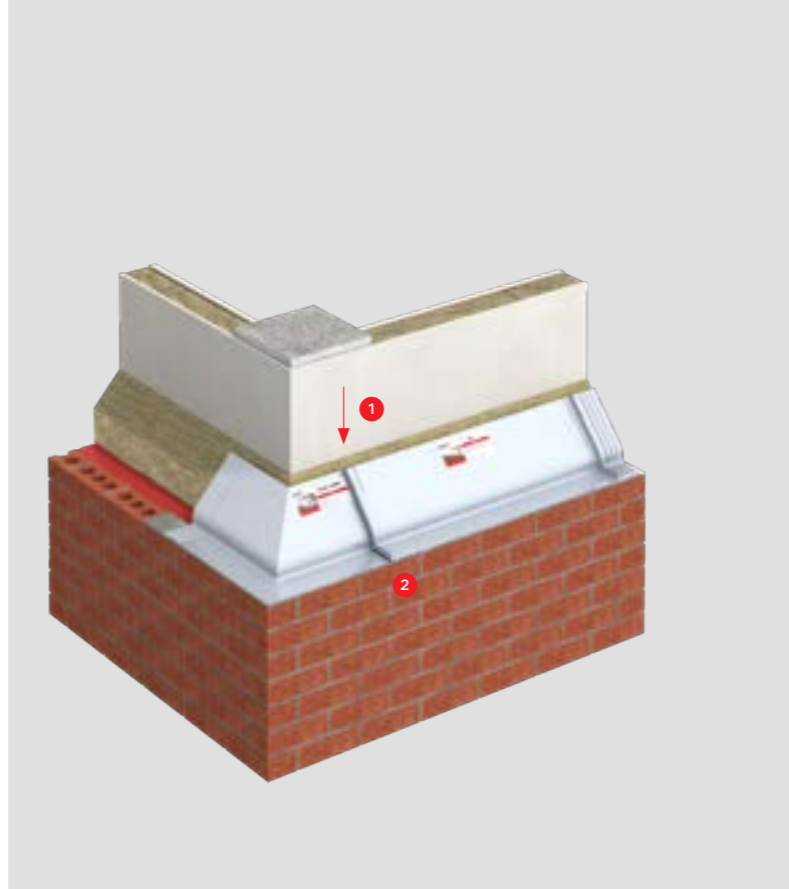

04 Connecting Trays

Assemble Jointing Piece **1** onto Brick Tray **2** by first, inserting Brick Tray into lower clip **3** then securing together at top using split pin **4**.

Ensure trays meet midway between ribbed sections.

Perp joint width adjustment can be achieved by sliding trays left or right within clips on top of Jointing Piece.

Ensure perp joint mortar is fully filled between and on top of Stop Ends between abutting trays.

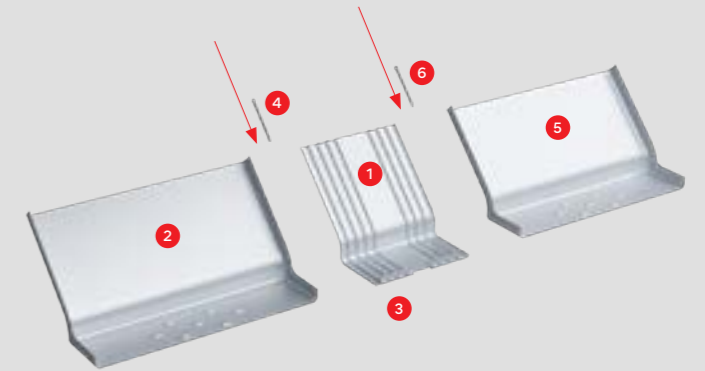

- 1** Jointing Piece
- 2** First Brick Tray
- 3** Lower Clip
- 4** First Split Pin
- 5** Second Brick Tray
- 6** Second Split Pin



Assemble Jointing Piece onto end of first Brick Tray, inserting into lower clip first then securing with split pin.

05 Locating Trays on Corner Units

Locate first Brick Tray into pre-installed clip on ribbed connection **1** and secure at top with split pin **2**.

Ensure overlapping Brick Tray is secured in correct alignment with corner tray by ensuring it is fully inserted within the clip.

All ribs must be covered by overlapping Brick Tray **3**. (Minimum of half brick overlap.)

Brick Trays can be adjusted horizontally within lower clip to match corner brick bond.

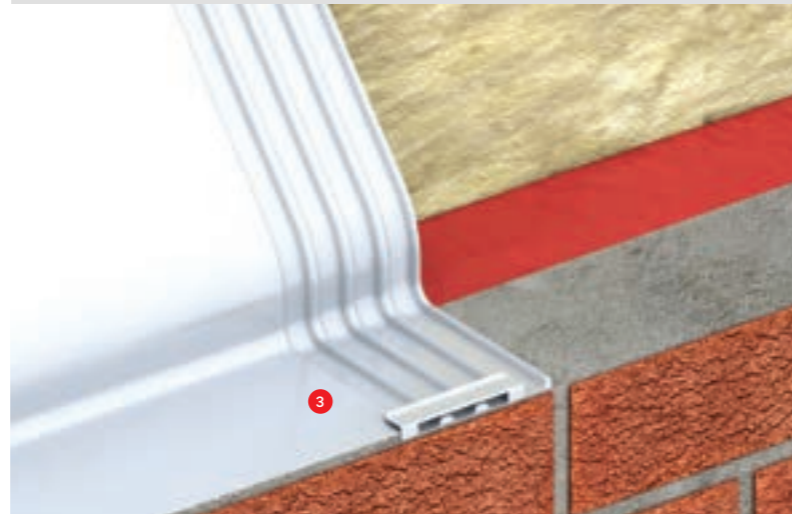
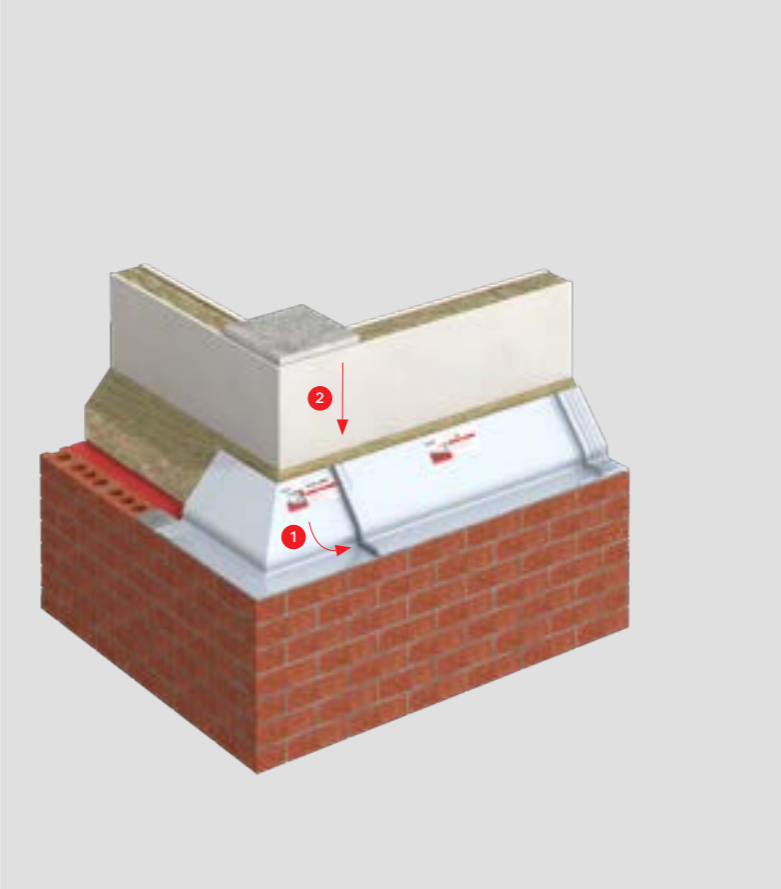

Split pins should be installed to ensure the sloped section of trays are held together to provide effective jointing.

06 'Buttered Up' Stop End

Stop Ends must be 'battered up' with mortar.

This restricts the free flow of moisture towards ribs and encourages moisture to drain via weeps vents.

Ensure any space between end of brick and Stop End **1** at reveals is fully filled with mortar.

This obstructs passage of moisture around end of brick and encourages moisture drainage via weep vents.



07 Weep Placement on Corner Units

Keyfix Non-combustible Stainless Steel Weep should be placed against 'battered up' Stop End or within 225mm from the outside of the overlapping brick tray Stop End ①. Two weeps must be placed on each corner unit to provide sufficient drainage.

Only stainless steel weeps can be used directly on top of stainless steel trays to avoid bi-metallic / electrolytic corrosion between dissimilar materials and provide optimum drainage to the system.

Zinc plated weeps must be placed on top of mortar bed to avoid bi-metallic / electrolytic corrosion between dissimilar materials.



Place weep in perp joint to outside of Stop End or within 225mm on right hand side of first tray.

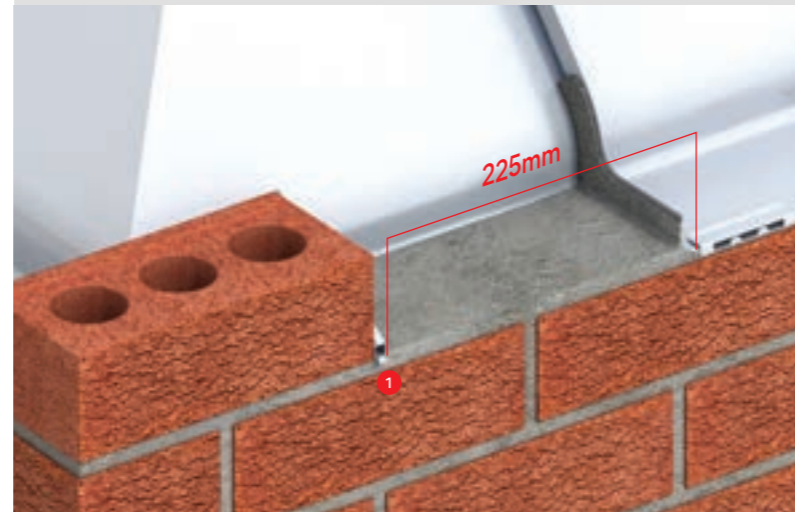

08 Bedding Mortar on Trays

Place half bed of mortar on top of trays and commence brickwork.

After locating Weep within 225mm from outside of 'Buttered Up' Brick Tray Stop End, weeps are placed at a maximum spacing of 900mm c/c with a minimum of one weep required on each Brick Tray.

Ensure mortar droppings are cleared from back of tray and weeps are free of all mortar.

It is good practice to use a wooden lath ① behind brickwork to catch mortar droppings. This lath can be periodically cleaned, raised and positioned on top of ties as brickwork progresses.



Commence brickwork over corner and first tray. Ensure perp joint is filled on top of weeps.

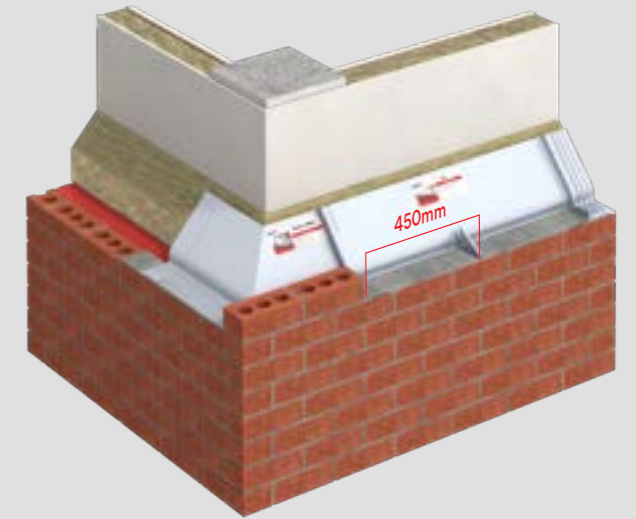

09 Ribbed Connections on Corner Units

All ribs must be covered by overlapping tray.
(Minimum of half brick overlap.)

Secondary weep holes in front edge of clips at ribbed connector to be kept clear of mortar when pointing up joints, to allow for adequate drainage.

Ribs and clip act as secondary drainage weeps in the event of high volumes of water pooling on top of corner trays.

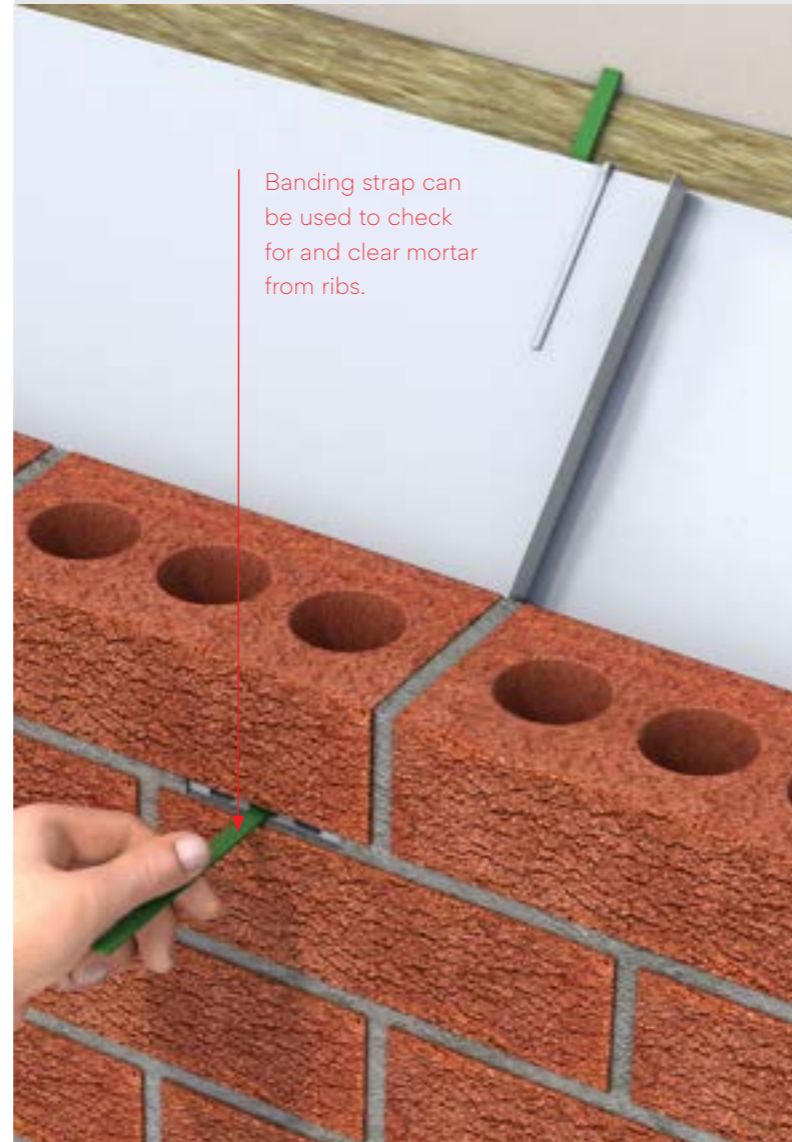

10 Continue Brickwork Around Perimeter of Building

Trays should be installed as before around the entire perimeter of the building, returning to the start point.

Keyfix Non-combustible Stainless Steel Weep should be placed against 'battered-up' Stop End or within 225mm from the outside of overlapping Brick Tray Stop End **1**.

To provide sufficient drainage, a minimum of two weeps per corner unit and a minimum of one weep per Brick Tray is required **2**.



Assemble final tray on top of half bed on corner tray and secure with split pin.

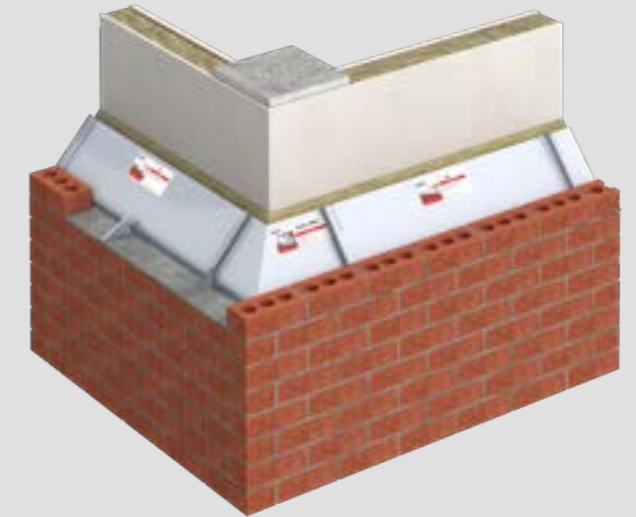

11 Membrane Overlap

A local strip of membrane should be installed over the space between tray and internal skin.

This is required to protect the install during construction and provide drainage of any condensation present within the cavity.

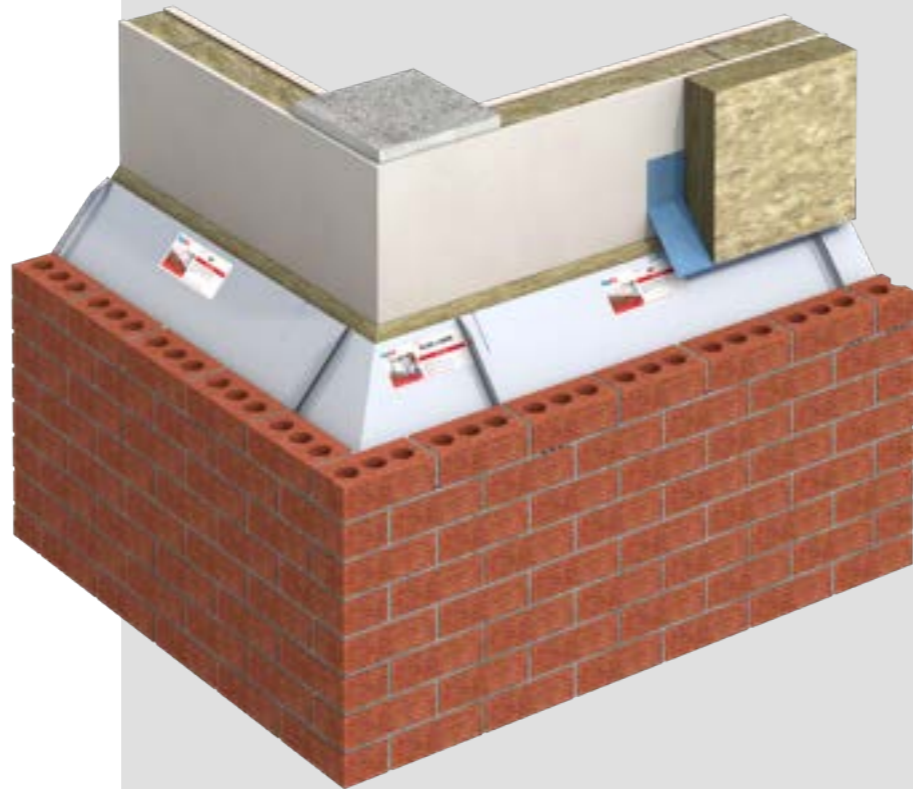

It is good practice to leave a strip of membrane to overlap trays to provide protection during construction.

12 Membrane Overlap

Where a localised strip of membrane is overlapped on top of the trays, it is considered good practice to fold over the corners of the trays to avoid any sharp edges penetrating the membrane ①.

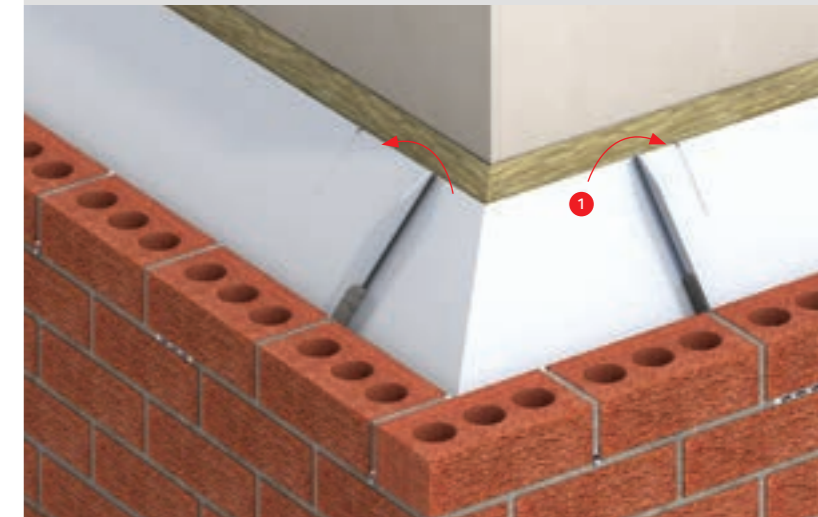
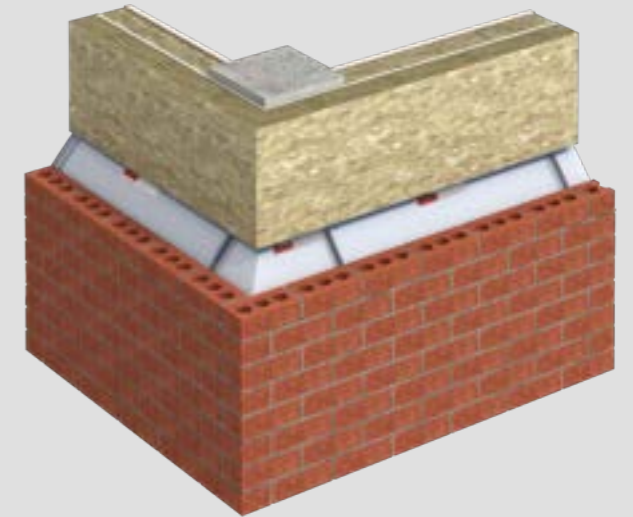



NCCT Technical Guidance

What is the function of a Cavity Tray?

A Cavity Tray is required over all bridges or penetrations of the cavity within an external wall.

Its primary function is to capture moisture running down the internal surface of the external skin of masonry, and moisture dripping off wall ties within the nominal 50mm 'clear cavity'.

Once captured, this moisture must be restricted from travelling horizontally along the length of the tray and instead must be expelled out of the cavity via weep vents placed at specified centres.

It is therefore essential that the Cavity Tray is continuous across the 'clear cavity' to ensure that all moisture captured is directed outwards and not obstructed by mortar droppings, creating a route inwards which could in turn saturate insulation etc.

Furthermore, it is important to ensure the horizontal section of a Cavity Tray is continuous and does not have any perforations which could redirect the captured moisture inwards. **It is also essential that a tray has no perforations in order to prevent rising damp.**

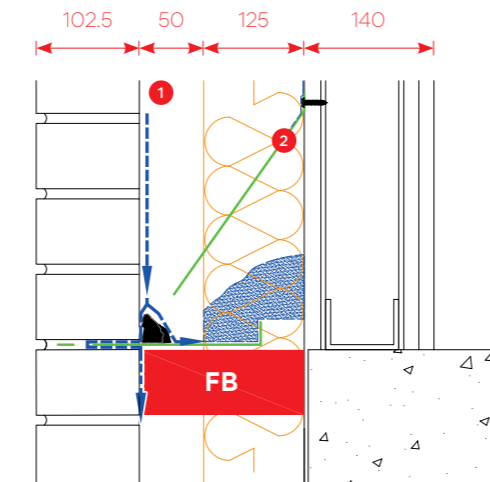

- 1 Moisture running down internal surface of external brickwork
- 2 Two part tray not continuous across the cavity

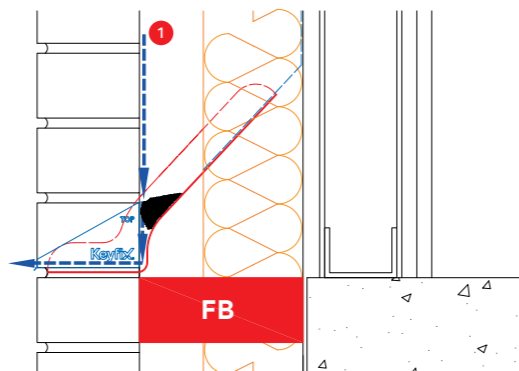

Can one NCCT be installed over several items within the cavity?

It is acceptable to protect more than one element i.e. fire barrier & masonry support, with a single Non-combustible Cavity Tray, provided the lowest item requiring protection is located within a maximum vertical height of 225mm from the Cavity Tray.

A NCCT should be installed as close as possible to the item it is protecting.

The logic behind this dimension is driven by brickwork bonds. If a soldier course was to be built over the item to be protected, the closest measurement the NCCT can be installed is 225mm.

Details which are outside of the above should be given additional consideration in relation to the area of masonry above, in order to assess exposure to moisture volumes and mortar droppings etc.

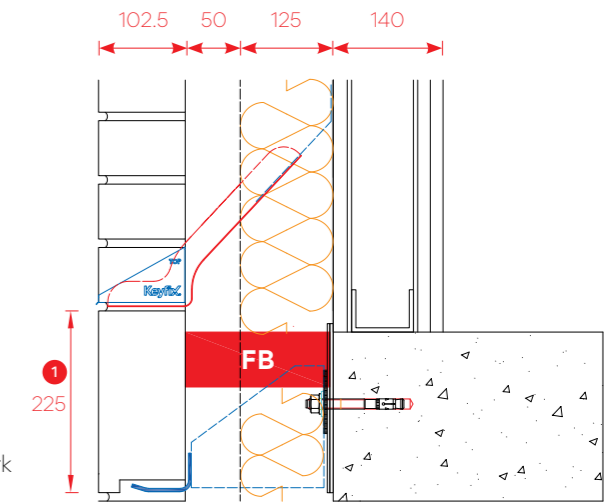

- 1 225mm vertical height

Does a Cavity Tray need to be fixed to, or supported by the internal skin?

All major Warranty Providers agree that where a Cavity Tray is rigid enough to be self-supporting across the clear cavity, it does not need to be fixed to the internal skin for support. This may differ in areas of very high exposure to wind driven rain such as the Scottish Highlands etc.

The Keyfix NCCT system with its integral Stop Ends preformed on each tray, is rigid enough to be self-supporting and therefore does not need to be fixed to, or supported by the internal skin. This in turn eliminates issues such as Thermal Bridging and Differential Movement which have been identified by Warranty Providers as an area of concern for metal cavity tray systems which are fixed to the internal skin. Cavity Tray systems which do not require support from the internal skin are known to be substantially easier and less expensive to install, whilst reducing interferences as a result of deviations in cavity width due to construction tolerances.

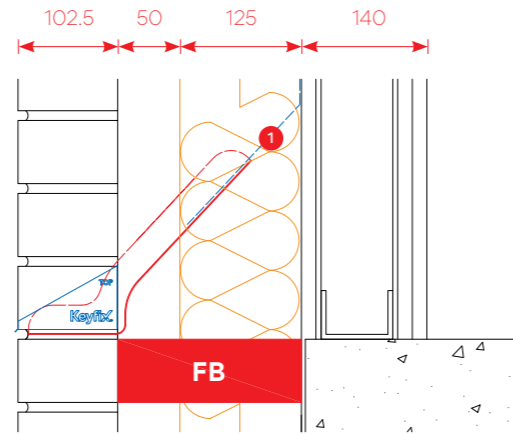

1
NCCT terminates within insulation
therefore creating no thermal bridge

Is a NCCT required between two skins of masonry just above ground level?

Cavity Trays when built between two skins of masonry are exempt from the updated Document B, however some design teams and clients will insist on NCCT's throughout the building to provide continuity of detailing. External walls built with two skins of masonry which have adequate provision for cavity drainage and mortar droppings may not be required (in discussion with Project Design Team / Client and Warranty Provider etc) to use a NCCT and instead install a horizontal Non Combustible Damp Proof Course (NCDPC) above finished ground level as shown.

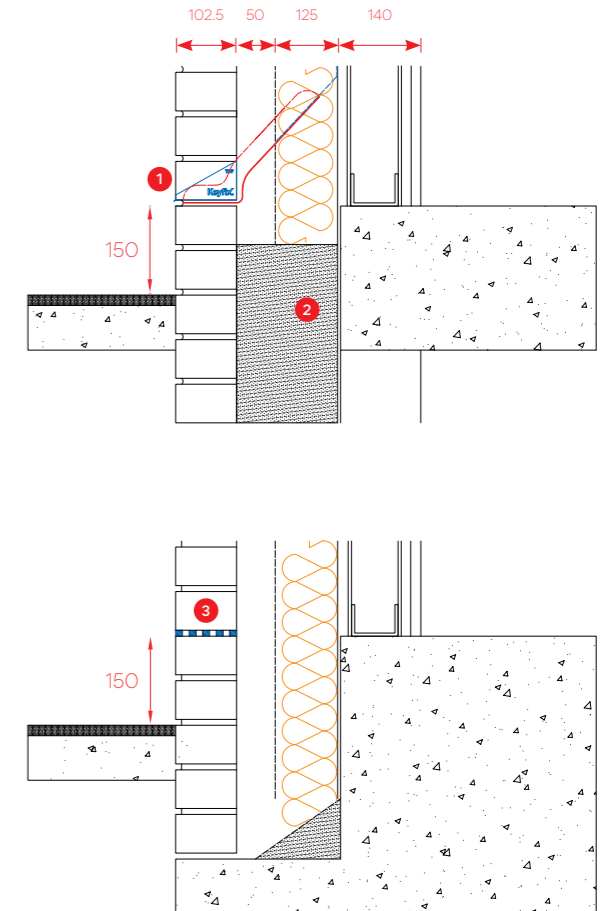

1
Non-combustible Cavity Tray NCCT
@ 150mm above finished ground level

2
Full Fill Cavity

3
Horizontal NCDPC @ 150mm above FGL

Does a breather membrane need to overlap a Cavity Tray or Cavity Tray Lintel?

Non-combustible Cavity Trays are tested independently of the internal skin and any other membranes. It is good practice to overlap a strip of membrane, to protect the insulation etc from the elements during construction and in the event of any interstitial condensation forming within the cavity this can be drained out on top of the tray. The membrane should overlap the top of the tray by 100mm. At corners, the strip of membrane should be overlapped and taped as per manufacturer's technical guidance.

1

Membrane tape sealed to weather board

2

Membrane lapped over NCCTL minimum 25mm

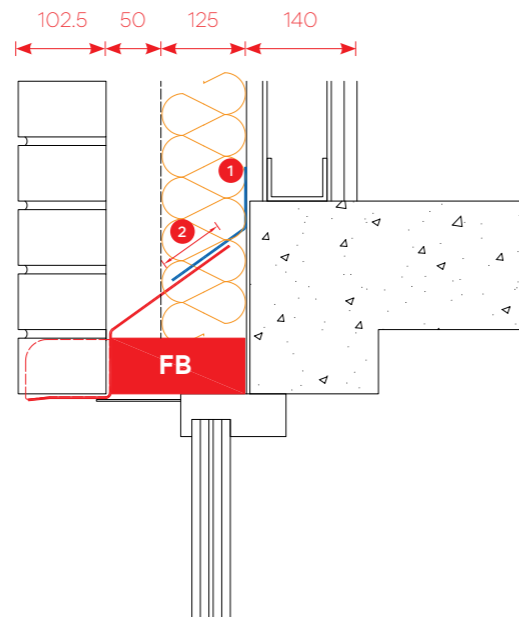

Why is it preferable to avoid use of tapes, sealants and mastics when creating joints in Cavity Trays?

The number 1 reason for reopening the cavity wall of a building after occupation is failures in joints of DPC's and Cavity Trays formed using tapes, sealants and mastics.

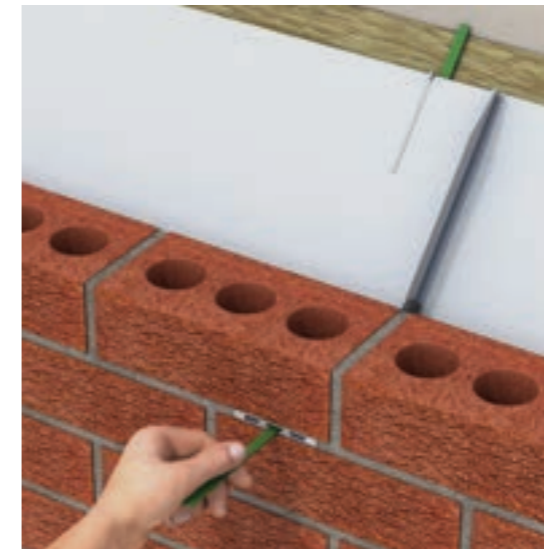

This can be as a result of workmanship or more often due to onsite conditions impacting the quality of adhesion between materials and tapes, sealants and mastics used to create a watertight joint.

Conditions caused by dust, moisture and temperature are commonly known to adversely impact the performance of tapes, sealants and mastics and therefore the joints formed using them.

Additionally, the integrity of a joint formed using tapes, sealants and mastics cannot be easily checked on site in a non-destructive manner.

The Keyfix ribbed overlapping joints allow for moisture proof joints to be formed without tapes or sealants, whilst also accommodating horizontal movement and allowing for non-destructive quality checking by onsite QC inspectors.

Can a Cavity Tray be cut onsite?

On site cutting and fabrication of Cavity Trays should be avoided at all costs. Fabrication, cutting and folding not carried out by the manufacturer can give rise to warranty disputes. All onsite alterations or fabrications should be signed off by the relevant Warranty Provider and / or the system Manufacturer. If a Cavity Tray clashes with another building component within the cavity (such as a wall tie or wind post), the Cavity Tray may be notched or cut around it, providing approval from the manufacturer has been agreed, and only where the cut / notch does not occur within the nominal 50mm clear cavity.

All cuts should be sealed around using an approved proprietary system.

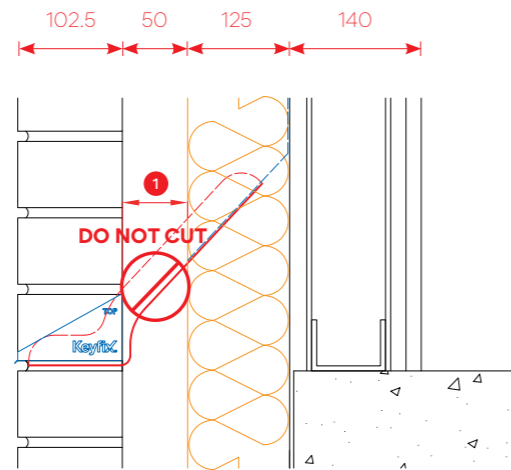

- 1 50mm Clear Cavity
- 2 At least 140mm total height in Cavity Tray
- 3 At least 100mm rise in Cavity Tray from front of cavity
- 4 NCCT - 100 with reduced profile due to available space required to protect masonry support system
- 5 Additional NCCT provided above to relieve 'moisture load' on reduced profile lower tray

If the space within the cavity does not allow for a standard Cavity Tray profile, can the profile be reduced?

Cavity Trays must conform to predetermined dimensions as shown below in order to perform correctly.

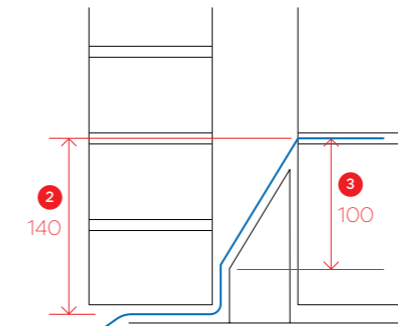

However where the available space within a cavity is restricted due to other components, it may be necessary to reduce the NCCT profile in order to provide protection where it is required. Reducing the NCCT profile below the recommended dimensions will reduce its effectiveness. Consideration must be given to the area of masonry above the tray through which wind driven rain may penetrate.

Where water ingress is considered to be a risk, an additional tray should be installed above to 'relieve' the reduced tray.

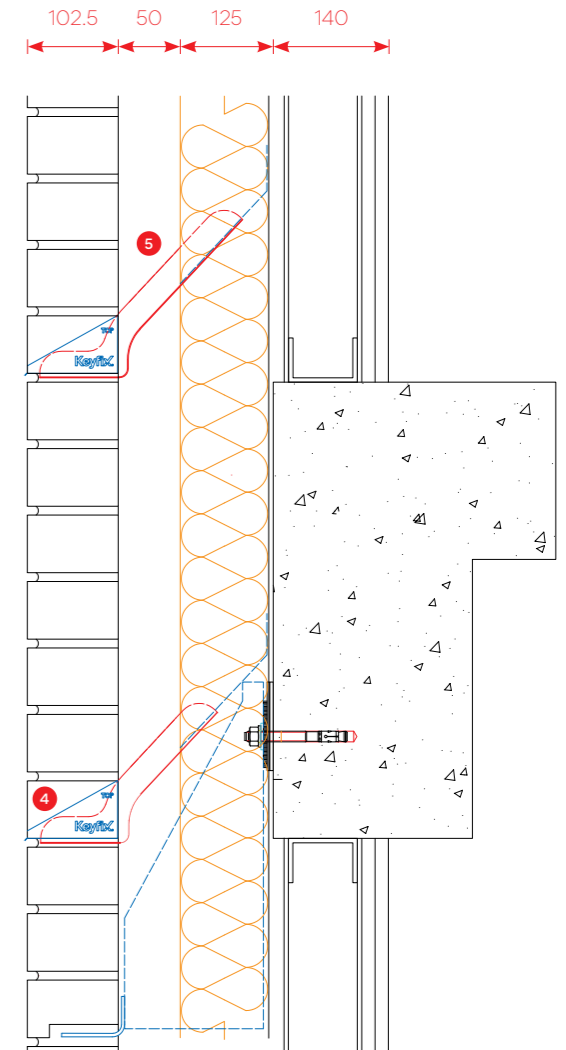

Why is it preferable to have an integral Stop End?

As the water collected on a Cavity Tray builds up it can travel along the horizontal length of the tray or lintel. Unless this movement of moisture is stopped before it gets to the end of the tray or lintel, the moisture can run over the end and back into the cavity or worse into the habitable space.



Proprietary Stop Ends can be adhered to the lintel or tray surface during installation, however this is not easily done and is difficult to supervise or inspect on site.

Site conditions can greatly affect the effectiveness of the adhesion. Cold, wet or dusty surfaces will reduce the quality of adhesion and accordingly the seal created when joining parts onsite.

Mechanically fixed / Integral Stop Ends are manufactured and assembled in a controlled environment and therefore guarantee a watertight joint, ensuring no moisture can escape off the surface of the tray or lintel unless via the intended weep vent.

Why is it preferable to use a Stainless Steel weep vent on a Stainless Steel Cavity Tray?

Only Stainless Steel weep vents can be installed directly on top of a stainless steel Cavity Tray, lintel or masonry support angle without risk of bi-metallic / electrolytic corrosion. Weep vents made from a dissimilar metal must be bedded on top of a layer of mortar to avoid bi-metallic / electrolytic corrosion.

Zinc Alloys can be a concern for some Warranty Providers in relation to corrosive attack from alkali in mortars.



How can wall tie distribution be achieved where Cavity Trays, fire barriers and masonry support are all present together?

Where a Cavity Tray fouls the provision of a wall tie or fixing within the notional 300mm of a masonry support angle or lintel, ties can be installed in courses below the Cavity Tray (fixed to MS brackets or slab edge), with subsequent ties then placed 300mm above this.

Increasing the quantity of wall ties is also good practice

- 1 Wall tie located below NCCT can be fixed to MS bracket / concrete slab
- 2 Additional wall tie max. 300mm above lower tie

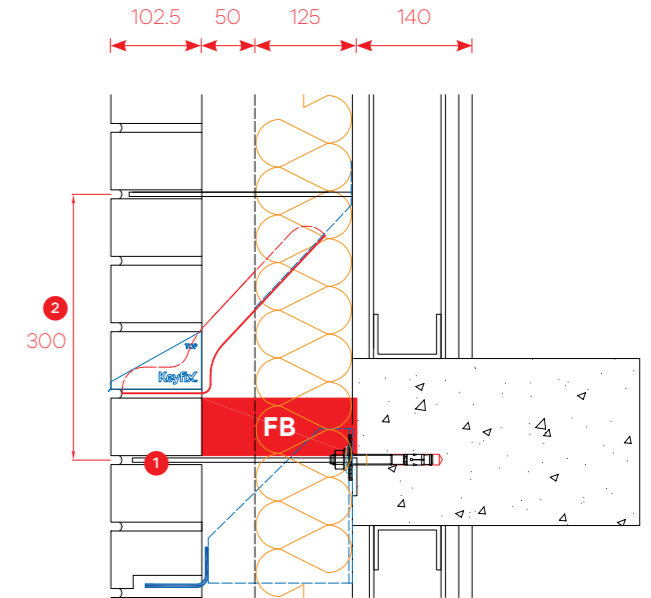

Sections shown within Technical Guidance are indicative only and have some details omitted for clarity.

Where is a Cavity Tray positioned when masonry support angle is inverted and positioned at FFL?

In cases where inverted masonry support brackets are installed as shown, the NCCT will be installed one course above the masonry support angle and therefore may need to start and stop between openings.

- 1 Non-combustible Cavity Tray installed one course above inverted MS
- 2 Inverted MS angle bracket to concrete slab

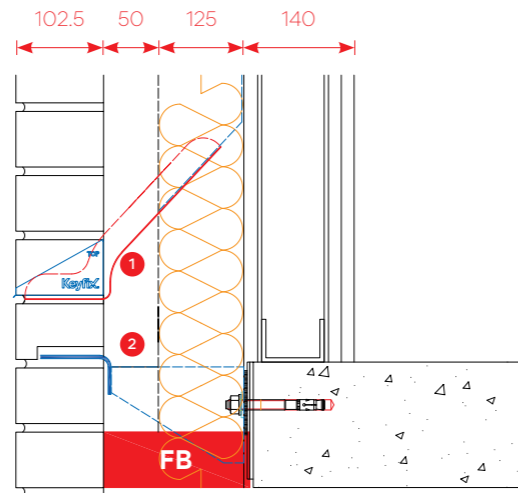

How are window / door reveals detailed?

Where window / door frames are located within the 102.5mm external masonry skin and the NCCT starts and stops between openings, the trays must be finished with an integral Stop

End to ensure moisture cannot escape off the tray ends and behind the window / door frames.

Where window / door frames are recessed greater than 102.5mm and the NCCT starts and stops between openings, the trays must return around the brickwork reveal with an integral Stop End in line with masonry / frame jamb.

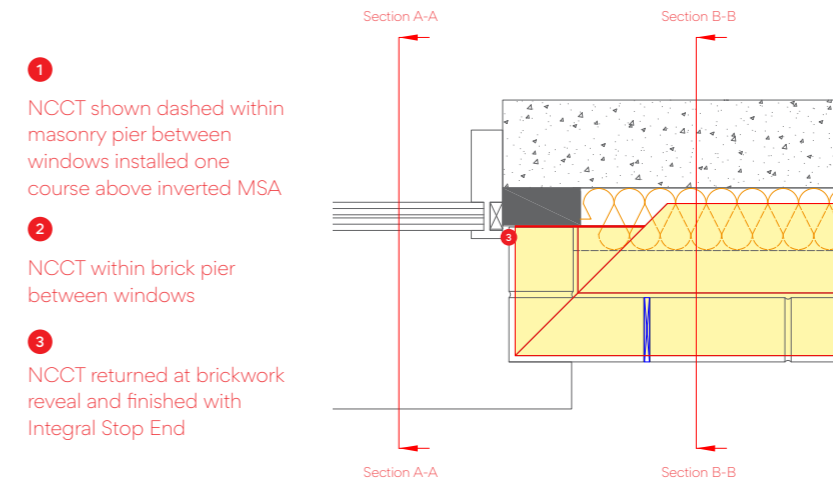
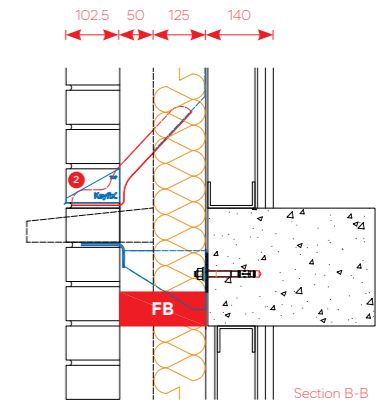
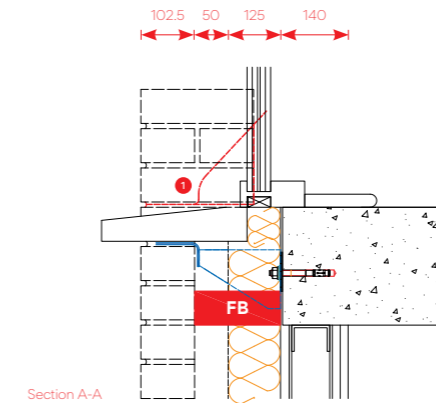

- 1 NCCT shown dashed within masonry pier between windows installed one course above inverted MSA
- 2 NCCT within brick pier between windows
- 3 NCCT returned at brickwork reveal and finished with Integral Stop End

Sections shown within Technical Guidance are indicative only and have some details omitted for clarity.

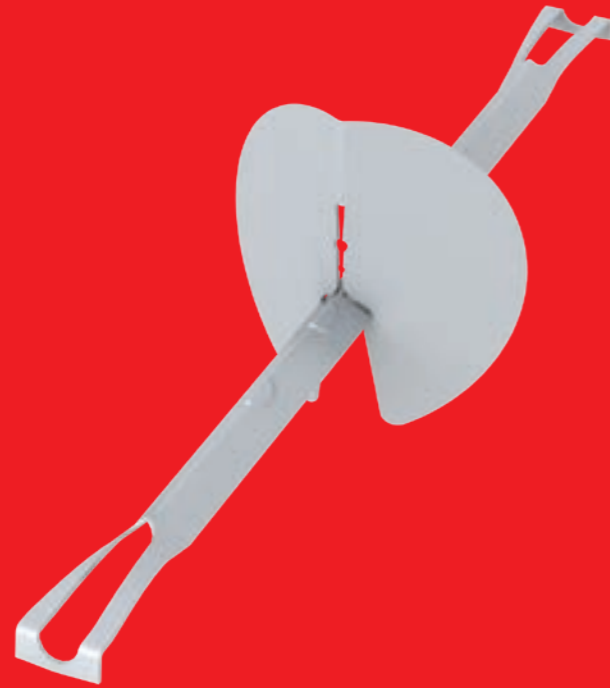

NCRD Non-combustible Retaining Disc

NCRD

Non-combustible Retaining Disc

Designed to work with majority of Frame Cramps and Type 1 Ties, the Keyfix Non-combustible Insulation Retaining Disc (NCRD) has a unique patented spring loaded action, which clamps the NCRD to the main body of the wall tie. The clamping action enables the disc to slide along the tie to retain the insulation in its required position.

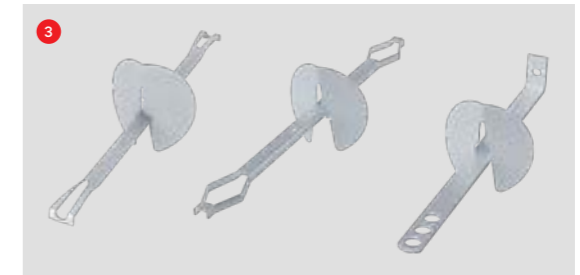
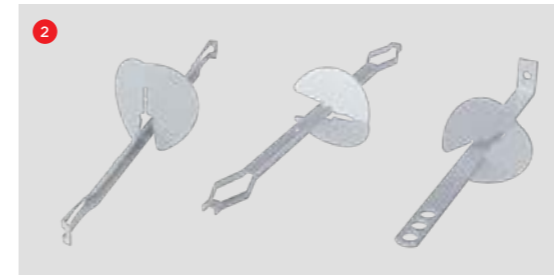

- 1 Fold NCRD at 135° along its main axis to provide varying clamping pressure on wall tie.
- 2 Insert the tie into the disc as shown in the diagram above.
- 3 To install NCRD onto Wall Tie, rotate tie until it 'clicks' into position.
- 4 Locate and fix Wall Tie in required position..
- 5 Install insulation on top of tie.
- 6 Slide disc inwards to hold insulation in place.

Innovation

never sleeps



NCCTL Non-combustible Cavity Tray Lintel

Keyfix has developed a solution

NCCTL

Non-combustible Cavity Tray Lintel

In buildings over 11m in height, Document B prevents the use of plastic DPCs. Galvanised lintels cannot be used without a DPC, as the DPC protects the galvanised surface against attack from chemicals present within mortars etc.

The Keyfix Non-combustible Cavity Tray Lintel offers a non-combustible stainless steel single leaf lintel with combined Cavity Tray. For use in an exterior masonry skin in conjunction with a non-masonry inner leaf such as a steel frame system, the NCCTL is a highly efficient and practical solution to the challenge of non-combustible cavity detailing.

- ✓ Non-combustible Class A1 for compliance with Document B in buildings over 11m in height.
- ✓ Stainless steel construction with mechanically fixed watertight Stop Ends.
- ✓ Facilitates speedy installation.
- ✓ Utilises traditional onsite trades, no additional specialist skills required.
- ✓ Standard load-bearing capabilities.

NHBC Standards clause 6.1 states that Cavity Trays should be provided at all interruptions to the cavity (e.g. windows and door openings and air bricks)

Unless Otherwise Protected.

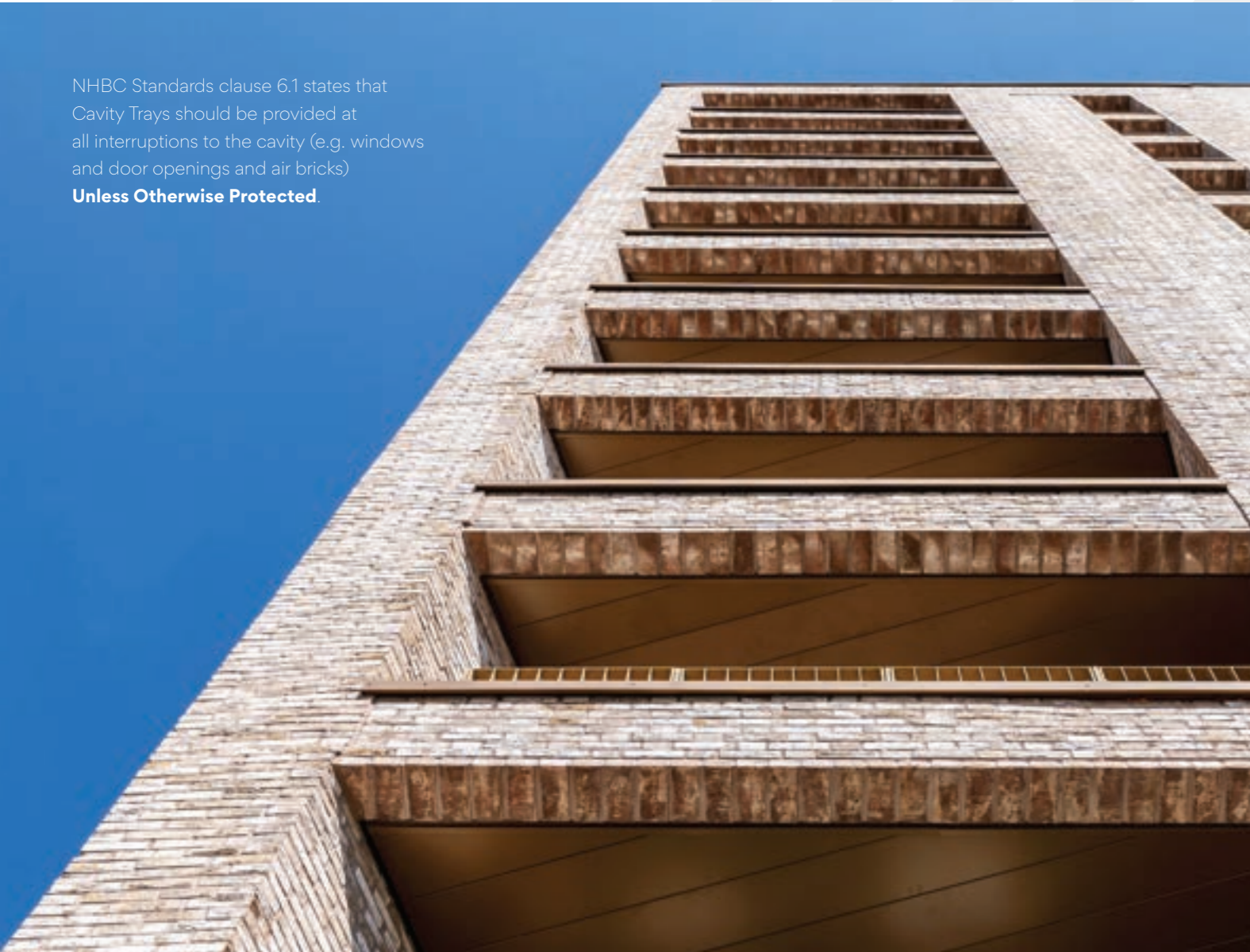

Cavity Trays should

- Provide an impervious barrier and ensure that water drains outwards.
- Cover the end of the lintel and project at least 25mm beyond the outer face of the cavity closer or, where a combined cavity tray and lintel is acceptable, give complete protection to the top of the reveal and vertical DPC.
- Provide drip protection to door and window heads.
- Have a 140mm minimum vertical height from the inside face of the outer leaf to the outside of the inner leaf.
- Be shaped to provide 100mm minimum vertical protection above points where mortar droppings could collect.
- Be provided where the cavity is bridged by air bricks, etc. and the DPC should extend 150mm beyond each side of the bridge.
- Where not otherwise protected (e.g. by a roof at an appropriate level), be provided over meter boxes.
- Be in one continuous piece or have sealed or welded joints.

1

At least 140mm total height in Cavity Tray.

2

At least 100mm rise in Cavity Tray from front of cavity.

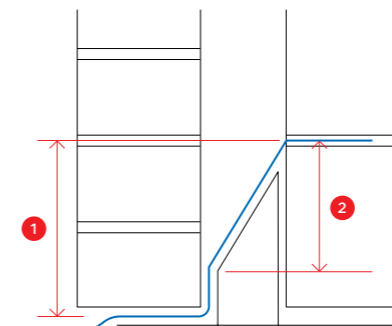



Standard
load-bearing
capabilities



Stainless steel construction
with mechanically fixed
watertight Stop Ends

NCCTL Specification

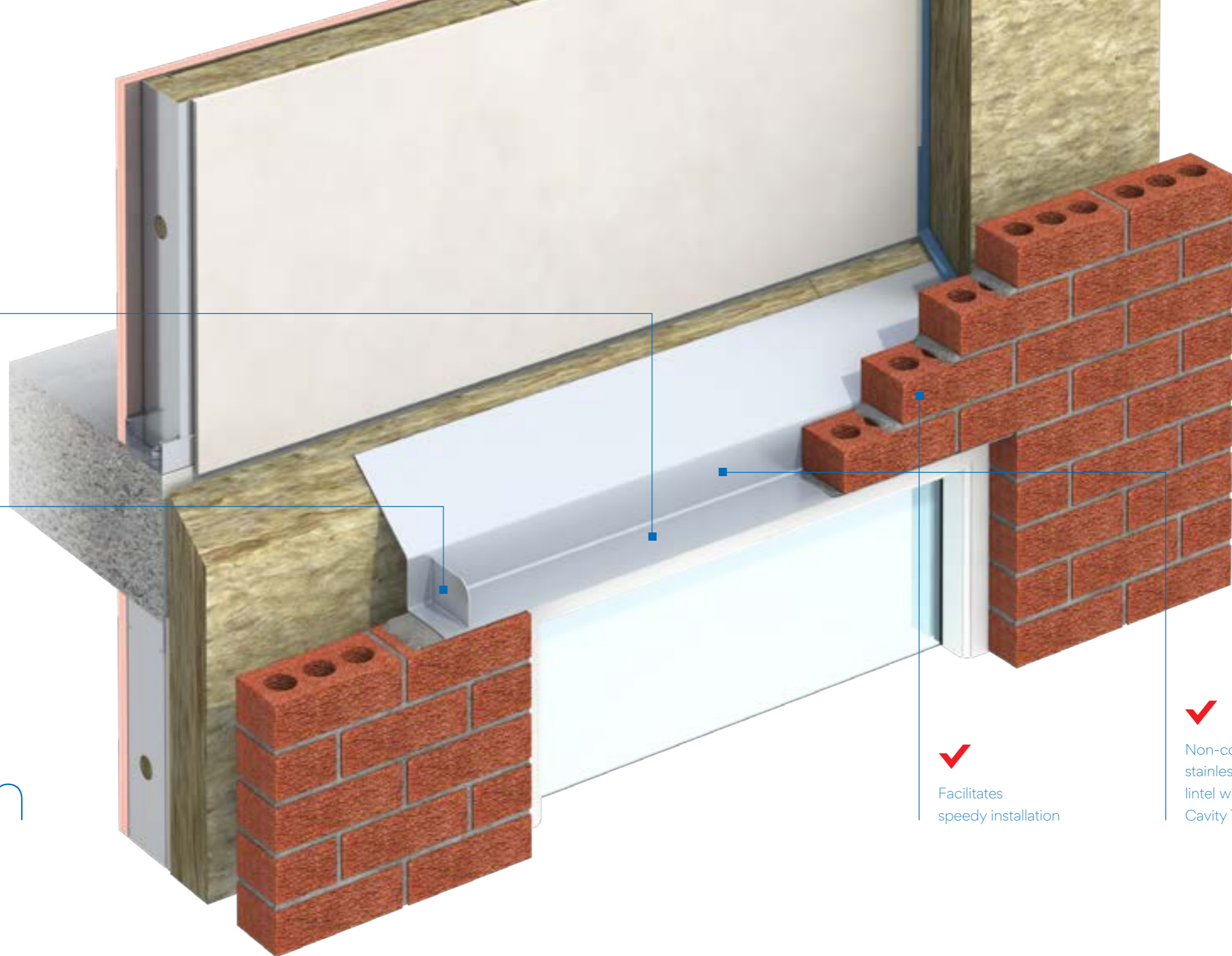

Facilitates
speedy installation



Non-combustible
stainless steel single leaf
lintel with combined
Cavity Tray

Why Specify Keyfix NCCTL?

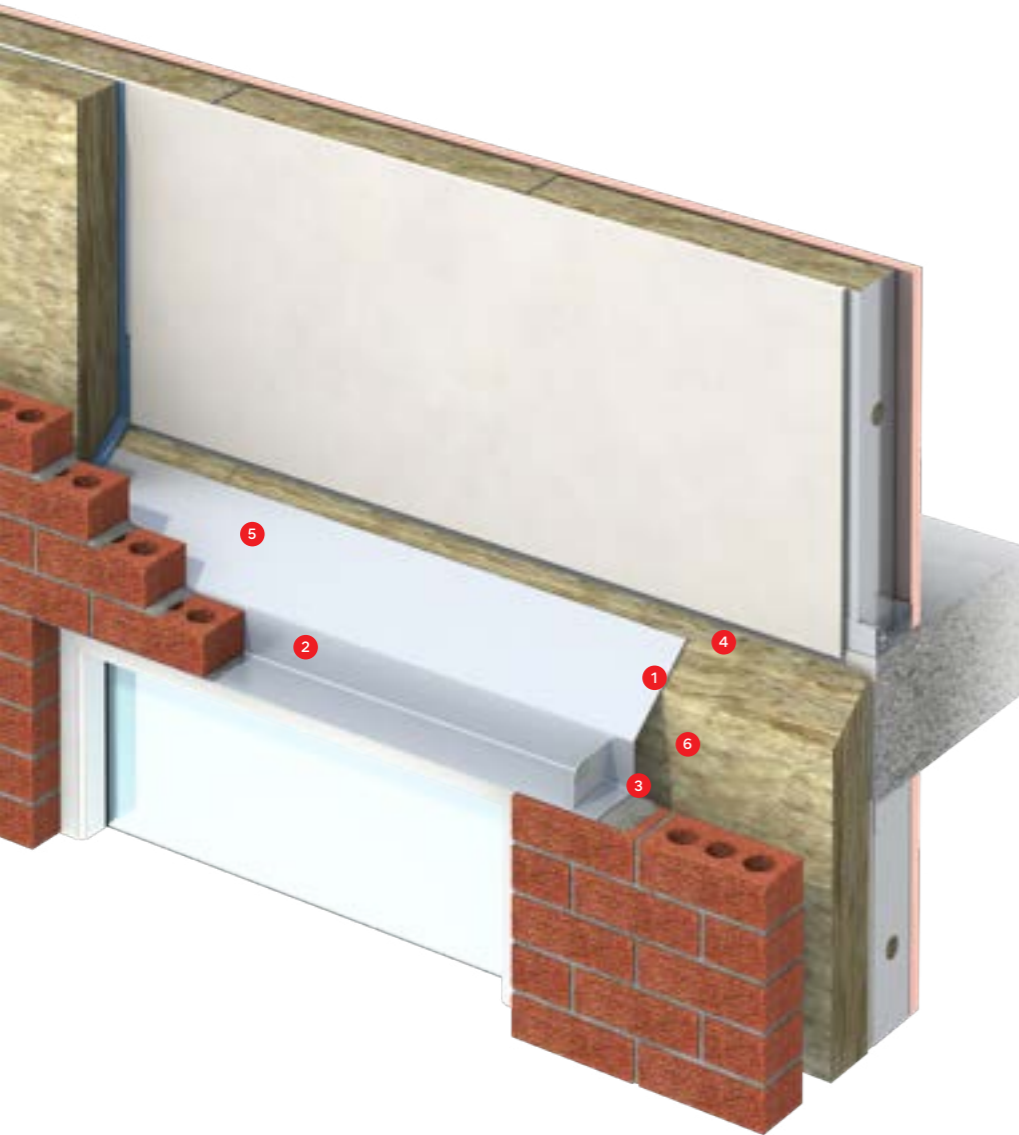

1 Non-combustible Class A1 Compliant

The Keyfix NCCTL is manufactured using Class A1 Non-combustible stainless steel offering a Non-combustible stainless steel single leaf lintel with combined Cavity Tray. The Keyfix NCCTL is suitable for use at over 11m in height where Document B prevents the use of plastic DPCs and where galvanised lintels cannot be used due to bi-metallic corrosion between dissimilar materials.



The NCCTL is a practical lintel solution which is built into the outer leaf as normal and gives easy access to membranes and insulation on the inner leaf.

2 High Performance Stainless Steel

The Keyfix NCCTL represents the ideal specification for all applications requiring Document B compliance as it is manufactured using Class A1 Grade 304 austenitic stainless steel. If required in coastal locations, Class A1 Grade 316 austenitic stainless steel should be specified to ensure British Standards and NHBC compliance requirements are met.



3 Mechanically Fixed Stop Ends

Watertight mechanically fixed Stop Ends are positioned within the brickwork perpendicular joints. The patented mechanically fixed Stop Ends eliminates installation errors caused by onsite conditions, ensuring any moisture present on the NCCTL cannot travel horizontally over the ends of the lintel but is channelled outwards via Keyfix Non-combustible weep. The location of the mechanically fixed Stop End allows lintels to be ordered and installed without advance knowledge of brickwork bonds setting out.



4 Ease of Installation

Keyfix NCCTL is a practical lintel solution which is built into the outer leaf as normal and facilitates easy access for the profiling of insulation and the overlap positioning of the cavity facing membrane if required. (This should be completed independently, once the lintel is securely built into the brickwork.)

5 Utilises Traditional Onsite Trades

The installation of the NCCTL requires no additional specialist skills. The ease of installation in the outer leaf combines the structural load bearing lintel with the advantages of a self-supporting Cavity Tray. The rigid self-supporting tray across the cavity enables the bricklayer to install the trays without assistance.

6 Standard Load-Bearing Capabilities

NCCTLs accommodate openings up to 3047.5mm, with lintel lengths based on brickwork opening sizes with the range based on 215mm stretcher bond as standard. Please contact the Keyfix Technical team if you require any variation from this.



Specification



Loading Assessment

The NCCTL accommodates openings up to 3047.5mm as standard. Contact Keyfix Technical Team for openings over 3047.5mm.

Mechanically Fixed Stop Ends

Mechanically fixed Stop Ends are prepositioned within the perpend joint to accommodate brickwork openings.

Standard Range

- Lintel lengths are based on brickwork openings sizes.
- Lintel range is based on 215mm stretcher bond as standard.
- NCCTLs accommodate openings up to 3047.5mm as standard.

Other variations are available on request. Please contact the Keyfix Technical Team with requirements for any variation from the above.

Determine brickwork opening

As the Stop End is prefixed to the lintel, the NCCTL must be specified by brickwork opening dimensions. Brickwork course and bond layout immediately below the lintel does not affect overall lintel length but will influence the lintel position over an opening. NB: Stop End positions are based on 215mm stretcher bond as standard. Please notify Keyfix Technical Team if you require any variation from this.

Lintel supported on reveals by full bricks

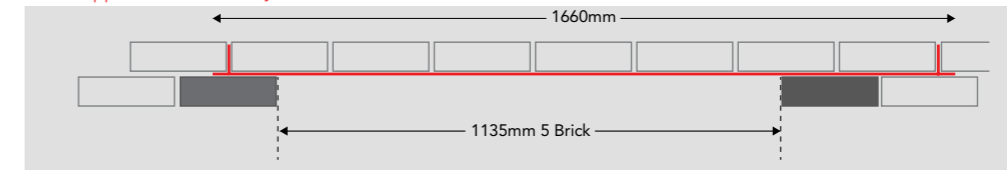

Lintel supported on reveals by half bricks

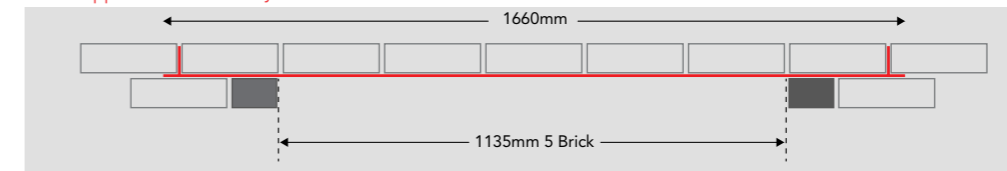

Lintel supported on reveals by a full brick and a half brick

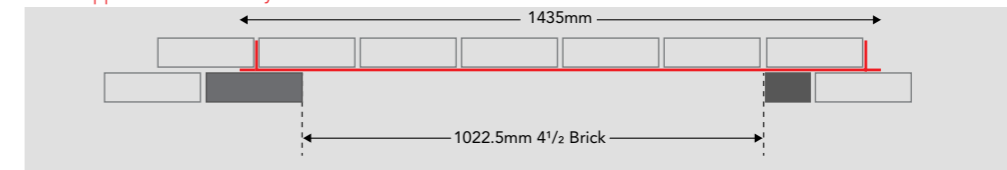

Lintel supported on reveals by a half brick and a full brick

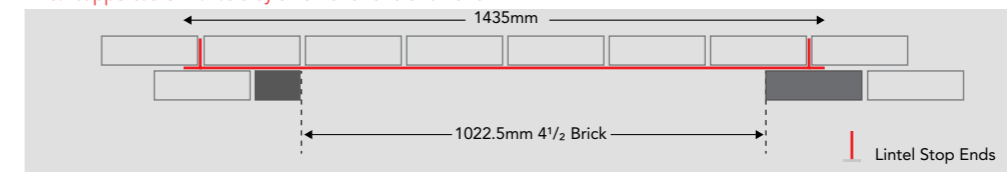

Assess Loading

The previous page demonstrates how the mechanically fixed Stop Ends can be positioned over the same opening dimension widths, taking into account, various brickwork bonds upon which the lintel may be bearing on.

The NCCTL range has been designed to accommodate any of the shown opening variations, therefore the required product should be specified by opening size.

Opening Width (mm)	Brick Modules	Lintel Length (mm)
460	2	985
572	2½	985
685	3	1210
797	3½	1210
910	4	1435
1022	4½	1435
1135	5	1660
1247	5½	1660
1360	6	1885
1472	6½	1885
1585	7	2110
1697	7½	2110
1810	8	2335
1922	8½	2335
2035	9	2560
2147	9½	2560
2260	10	2785
2372	10½	2785
2485	11	3010
2597	11½	3010
2710	12	3235
2822	12½	3235
2935	13	3460
3047	13½	3460

NCCTL 140 Loading Tables

Standard Range			
Brickwork Opening (mm)	460 - 1472	1585-1922	2035-3047
Lintel Height (mm)	179	229	279
Total UDL (kN)	6	10	8

Heavy Duty Range			
Brickwork Opening (mm)	460 - 1472	1585-1922	2035-3047
Lintel Height (mm)	229	279	279
Total UDL (kN)	13	17	18

Extra Heavy Duty Range			
Brickwork Opening (mm)	460 - 1472	1585-1922	—
Lintel Height (mm)	279	279	—
Total UDL (kN)	26	36	—

Other cavity sizes available upon request

NCCTL Lintel Height

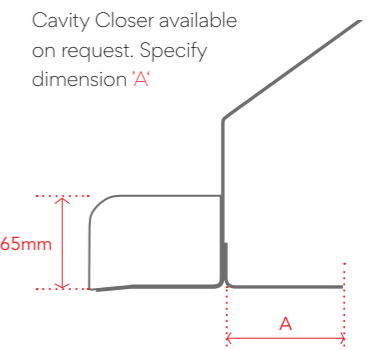
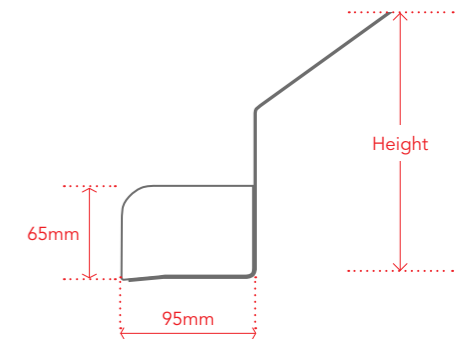

NCCTL 100
Loading Tables

Standard Range			
Brickwork Opening (mm)	460 - 1472	1585-1922	2035-3047
Lintel Height (mm)	179	229	279
Total UDL (kN)	6	8	7

Heavy Duty Range			
Brickwork Opening (mm)	460 - 1472	1585-1922	2035-3047
Lintel Height (mm)	229	279	279
Total UDL (kN)	13	17	15

Extra Heavy Duty Range			
Brickwork Opening (mm)	460 - 1472	1585-1922	—
Lintel Height (mm)	279	279	—
Total UDL (kN)	26	36	—

NCCTL
Lintel Height

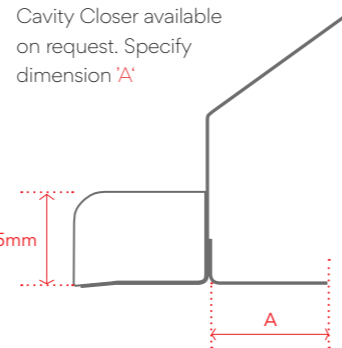
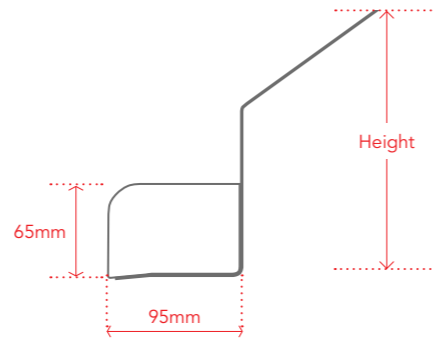

NCCTL 50
Loading Tables

Standard Range			
Brickwork Opening (mm)	460 - 1472	1585-1922	2035-3047
Lintel Height (mm)	179	229	279
Total UDL (kN)	5	7	6

Heavy Duty Range			
Brickwork Opening (mm)	460 - 1472	1585-1922	2035-3047
Lintel Height (mm)	229	279	279
Total UDL (kN)	12	14	15

Extra Heavy Duty Range			
Brickwork Opening (mm)	460 - 1472	1585-1922	—
Lintel Height (mm)	279	279	—
Total UDL (kN)	24	36	—

NCCTL
Lintel Height

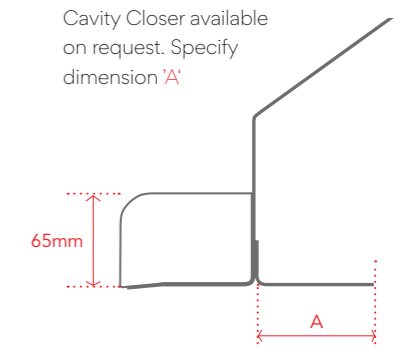
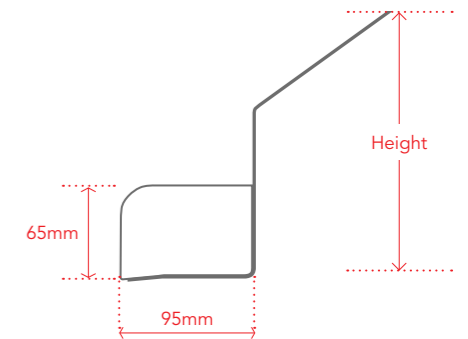

01 Minimum 150mm End Bearing

Lintels should be installed with a minimum end bearing of 150mm taking into account the positioning of the lintel's Stop Ends. The lintel should be bedded in mortar and levelled along its length and across its width.

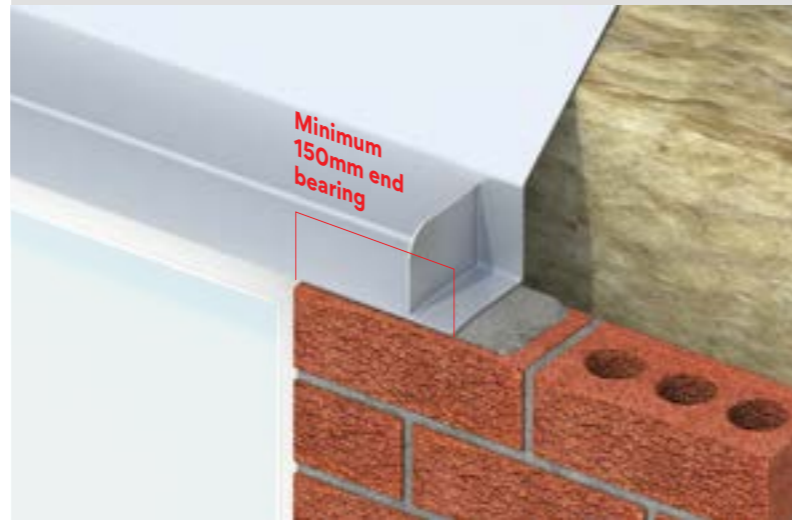

02 Maximum overhang 25mm

The masonry above the lintel should be built in accordance with BS EN 1996-2-2006. Masonry must not overhang the lintel flange by more than 25mm.

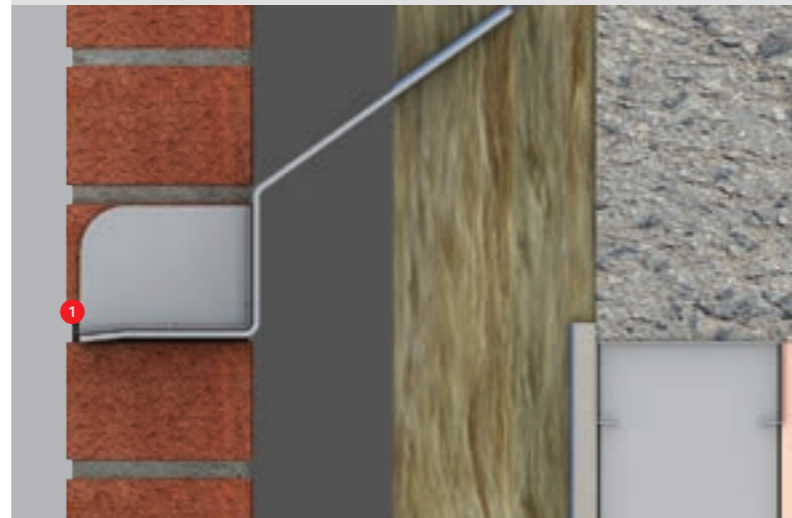

1 Maximum overhang 25mm

03 Temporary Propping

Temporary propping beneath the lintel can be used to facilitate speed of construction.

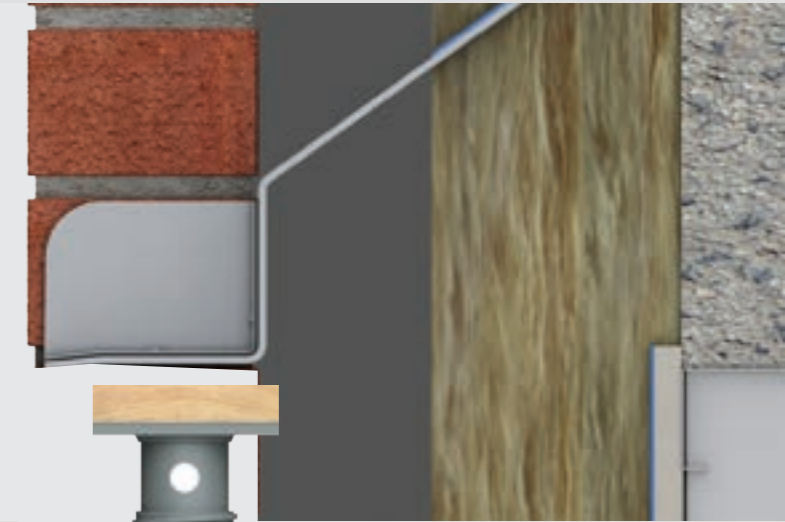

04 External Lintel Flange

The external lintel flange must project beyond the window / door frame.

CAUTION

Do not cut lintels to length or modify them in any way without consulting a Keyfix engineer.





Keyfix Limited NI

Ballyreagh Industrial Estate
Sandholes Road
Cookstown
BT80 9DG

Keyfix Limited GB

Ryder Close
Cadley Hill Industrial Estate
Swadlincote
DE11 9EU

T +44 (0)28 8676 7508

E info@keyfix.com

keyfix.com

This Product Guide will undergo various updates as we continually develop our innovative range of Non-combustible solutions. Please contact a member of our Technical team for the latest information about our product range.

Fix+Forget

